

# OptiSystem

## Getting Started

Optical Communication System Design Software

---

Version 12





---

# OptiSystem

## Getting Started

Optical Communication System Design Software

---

### **Copyright © 2013 Optiwave**

All rights reserved.

All OptiSystem documents, including this one, and the information contained therein, is copyright material.

No part of this document may be reproduced, stored in a retrieval system, or transmitted in any form or by any means whatsoever, including recording, photocopying, or faxing, without prior written approval of Optiwave.

### **Disclaimer**

Optiwave makes no representation or warranty with respect to the adequacy of this documentation or the programs which it describes for any particular purpose or with respect to its adequacy to produce any particular result. In no event shall Optiwave, its employees, its contractors or the authors of this documentation be liable for special, direct, indirect or consequential damages, losses, costs, charges, claims, demands, or claim for lost profits, fees or expenses of any nature or kind.



# Technical Support

---

If you purchased Optiwave software from a distributor that is not listed here, please send technical questions to your distributor.

## Optiwave

**Tel** (613) 224-4700

**Fax** (613) 224-4706

**E-mail** [support@optiwave.com](mailto:support@optiwave.com)

**URL** [www.optiwave.com](http://www.optiwave.com)

## Canada/US

## Optiwave Japan

**Tel** +81.43.375.2644

**Fax** +81.43.375.2644

**E-mail** [support@optiwave.jp](mailto:support@optiwave.jp)

**URL** [www.optiwave.jp](http://www.optiwave.jp)

## Japan

## Optiwave Europe

**Tel** +33 (0) 494 08 27 97

**Fax** +33 (0) 494 33 65 76

**E-mail** [support@optiwave.com](mailto:support@optiwave.com)

**URL** [www.optiwave.eu](http://www.optiwave.eu)

## Europe



---

# Table of contents

---

<b>Installing OptiSystem .....</b>	<b>1</b>
Hardware and software requirements .....	1
Protection key.....	1
OptiSystem directory .....	2
Installation .....	2
Technical support .....	2
<b>Introduction .....</b>	<b>3</b>
Benefits .....	4
Applications.....	4
Samples library.....	4
Main features .....	5
Notes: .....	7
<b>Quick Start .....</b>	<b>9</b>
Starting OptiSystem.....	9
Main parts of the GUI .....	11
Component parameters .....	18
Global parameters.....	25
Notes: .....	34
<b>Appendix A: Global Parameters .....</b>	<b>35</b>

Simulation parameters.....	38
Signals parameters .....	43
Noise parameters .....	45
Spatial Effects Parameters .....	46
Signal Tracing Parameters .....	47
<b>Appendix B: Signal representation .....</b>	<b>49</b>
Binary signals.....	50
M-Ary Signals .....	50
Electrical signals .....	50
Optical signals.....	52



---

# Installing OptiSystem

---

Before installing OptiSystem, ensure the system requirements described below are available.

## Hardware and software requirements

OptiSystem requires the following minimum system configuration:

- PC with Pentium 3 processor or equivalent
- Microsoft Windows XP, Windows Vista or Windows 7 or 8 (32-bit or 64-bit).
- 400 MB free hard disk space
- 1024 x 768 graphic resolution, minimum 65536 colors
- 128 MB of RAM (recommended)
- Internet Explorer 5.5 or higher
- DirectX 8.1 or higher

## Protection key

A hardware protection key is supplied with the software.

**Note:** Please ensure that the hardware protection key is NOT connected during the installation of OptiSystem.

To ensure that OptiSystem operates properly, verify the following:

- The protection key is properly connected to the parallel/USB port of the computer.
- If you use more than one protection key, ensure that there is no conflict between the OptiSystem protection key and the other keys.

**Note:** Use a switch box to prevent protection key conflicts. Ensure that the cable between the switch box and the computer is a maximum of one meter long.

## OptiSystem directory

By default, the OptiSystem installer creates an OptiSystem directory on your hard disk. The OptiSystem directory contains the following subdirectories:

- **\bin** — executable files, dynamic linked libraries, and help files
- **\components** — OptiSystem component parameters from vendors
- **\documentation** — OptiSystem support documentation
- **\libraries** — OptiSystem component libraries
- **\samples** — OptiSystem example files

**Note:** For the users of the **Amplifier Edition** of OptiSystem, refer to the 'Optical Amplifiers' folder under '\Samples'. For the users of the **Multimode Edition** of OptiSystem, refer to the '\Multimode' folder under '\Samples'.

## Installation

We recommend that you exit all Windows programs before running the setup program. To install OptiSystem, perform the following procedure.

- | Step | Action   |
|------|--|
| 1    | Log on as the Administrator, or log onto an account with Administrator privileges.               |
| 2    | Insert the OptiSystem CD into your CD ROM drive.   |
| 3    | On the Taskbar, click <b>Start</b> and select <b>Run</b> .<br><i>The Run dialog box appears.</i> |
| 4    | In the <b>Run</b> dialog box, type <b>F:\setup.exe</b> , where <b>F</b> is your CD ROM drive.    |
| 5    | Click <b>OK</b> and follow the screen instructions and prompts.                                  |
| 6    | When the installation is complete, reboot your computer.   |

## Technical support

<b>Phone</b>	(613) 224-4700—Monday to Friday, 9:00 a.m. to 5:00 p.m. Eastern Standard Time
<b>Fax</b>	(613) 224-4706
<b>E-Mail</b>	<a href="mailto:support@optiwave.com">support@optiwave.com</a>
<b>URL</b>	<a href="http://www.optiwave.com">www.optiwave.com</a>

---

# Introduction

---

Optical communication systems are increasing in complexity on an almost daily basis. The design and analysis of these systems, which normally include nonlinear devices and non-Gaussian noise sources, are highly complex and extremely time-intensive. As a result, these tasks can now only be performed efficiently and effectively with the help of advanced new software tools.

OptiSystem is an innovative optical communication system simulation package that designs, tests, and optimizes virtually any type of optical link in the physical layer of a broad spectrum of optical networks, from analog video broadcasting systems to intercontinental backbones.

OptiSystem is a stand-alone product that does not rely on other simulation frameworks. It is a system level simulator based on the realistic modeling of fiber-optic communication systems. It possesses a powerful new simulation environment and an hierarchical definition of components and systems. Its capabilities can be extended easily with the addition of user components, and can be seamlessly interfaced to a wide range of tools.

A comprehensive Graphical User Interface (GUI) controls the optical component layout and netlist, component models, and presentation graphics (see [Figure 1 on page 10](#)).

The extensive library of active and passive components includes realistic, wavelength-dependent parameters. Parameter sweeps allow you to investigate the effect of particular device specifications on system performance.

Created to address the needs of research scientists, optical telecom engineers, system integrators, students, and a wide variety of other users; OptiSystem satisfies the demand of the booming photonics market for a powerful and easy-to-use optical system design tool.

## Benefits

- Rapid, low-cost prototyping
- Global insight into system performance
- Straightforward access to extensive sets of system characterization data
- Automatic parameter scanning and optimization
- Assessment of parameter sensitivities aiding design tolerance specifications
- Dramatic reduction of investment risk and time-to-market
- Visual representation of design options and scenarios to present to prospective customers

## Applications

OptiSystem allows for the design automation of virtually any type of optical link in the physical layer, and the analysis of a broad spectrum of optical networks, from long-haul systems to MANs and LANs.

OptiSystem's wide range of applications include:

- Optical communication system design from component to system level at the physical layer
- CATV or TDM/WDM network design
- Passive optical networks (PON) based FTTx
- Free space optic (FSO) systems
- Radio over fiber (ROF) systems
- SONET/SDH ring design
- Transmitter, channel, amplifier, and receiver design
- Dispersion map design
- Estimation of BER and system penalties with different receiver models
- Amplified system BER and link budget calculations

## Samples library

OptiSystem includes an extensive library of sample optical design (.osd) files (in excess of 200) that can be used as templates for optical design projects or for learning and demonstration purposes. These files can be found in the "samples" folder of the root directory where Optiwave is installed.

## Main features

The main features of the OptiSystem interface include:

Feature	Description
<b>Component Library</b>	To be fully effective, component modules must be able to reproduce the actual behavior of the real device and specified effects according to the selected accuracy and efficiency. The OptiSystem Component Library includes hundreds of components, all of which have been carefully validated in order to deliver results that are comparable with real life applications.
<b>Measured components</b>	The OptiSystem Component Library allows you to enter parameters that can be measured from real devices. It integrates with test and measurement equipment from different vendors.
<b>Integration with Optiwave Software Tools</b>	OptiSystem allows you to employ specific Optiwave software tools for integrated and fiber optics at the component level: OptiAmplifier, OptiBPM, OptiGrating, WDM_Phasar, OptiFiber & OptiSPICE.
<b>Mixed signal representation</b>	OptiSystem handles mixed signal formats for optical and electrical signals in the Component Library. OptiSystem calculates the signals using the appropriate algorithms related to the required simulation accuracy and efficiency.
<b>Quality and performance algorithms</b>	In order to predict the system performance, OptiSystem calculates parameters such as BER and Q-Factor using numerical analysis or semi-analytical techniques for systems limited by inter symbol interference and noise.
<b>Advanced visualization tools</b>	Advanced visualization tools produce OSA Spectra, signal chirp, eye diagrams, polarization state, constellation diagrams and much more. Also included are WDM analysis tools listing signal power, gain, noise figure, and OSNR per channel.
<b>Data monitors</b>	You can select component ports to save the data and attach monitors after the simulation ends. This allows you to process data after the simulation without recalculating. You can attach an arbitrary number of visualizers to the monitor at the same port.
<b>Hierarchical simulation with subsystems</b>	To make a simulation tool flexible and efficient, it is essential to provide models at different abstraction levels, including the system, subsystem, and component levels. OptiSystem features a truly hierarchical definition of components and systems, enabling you to employ specific software tools for integrated and fiber optics at the component level, and allowing the simulation to be as detailed as the desired accuracy dictates.

Feature	Description
<b>User-defined components</b>	You can incorporate new components based on subsystems and user-defined libraries, or use co-simulation with a third party tool such as MATLAB or Simulink.
<b>Powerful Script language</b>	You can enter arithmetical expressions for parameters and create global parameters that can be shared between components and subsystems using standard VB Script language. The script language can also manipulate and control OptiSystem, including calculations, layout creation and post-processing when using the script page.
<b>State-of-the-art calculation data-flow</b>	The Calculation Scheduler controls the simulation by determining the order of execution of component modules according to the selected data flow model. The main data flow model that addresses the simulation of the transmission layer is the Component Iteration Data Flow (CIDF). The CIDF domain uses run-time scheduling, supporting conditions, data-dependent iteration, and true recursion.
<b>Multiple layouts</b>	You can create many designs using the same project file, which allows you to create and modify your designs quickly and efficiently. Each OptiSystem project file can contain many design versions. Design versions are calculated and modified independently, but calculation results can be combined across different versions, allowing for comparison of the designs.
<b>Report page</b>	A fully customizable report page allows you to display any set of parameters and results available in the design. The produced reports are organized into resizable and moveable spreadsheets, text, 2D and 3D graphs. It also includes HTML export and templates with pre-formatted report layouts.
<b>Parameter sweeps and optimizations</b>	Simulations can be repeated with an iterated variation of the parameters. OptiSystem can also optimize any parameter to minimize or maximize any result or can search for target results. You can combine multiple parameter sweeps and multiple optimizations.
<b>OptiPerformer</b>	For any given system topology and component specification scenario, a full OptiSystem project can be encrypted and exported to OptiPerformer. OptiPerformer users can then vary any parameter within defined specification ranges, and observe resulting system effects via detailed graphics and reports.
<b>Bill of materials</b>	OptiSystem provides a cost analysis table of the system being designed, arranged by system, layout or component. Cost data can be exported to other applications or spreadsheets.

**Notes:**



## INTRODUCTION





# Quick Start

---

This section describes how to load a design, run a simulation, edit local and global parameters, and obtain results. The most efficient way to become familiar with OptiSystem is to complete the lessons in the Tutorials, where you learn how to use the software by solving problems.

**Note:** For the users of the **Amplifier Edition** of OptiSystem we recommend to follow **Lesson 7: Optical Amplifiers - Designing optical fiber amplifiers and fiber lasers**, and for the users of the **Multimode Edition** of OptiSystem we recommend to follow **Lesson 8: Optical Systems - Working with multimode components**. Both lessons are available in the OptiSystem tutorials book.

## Starting OptiSystem

To start **OptiSystem**, perform the following action.

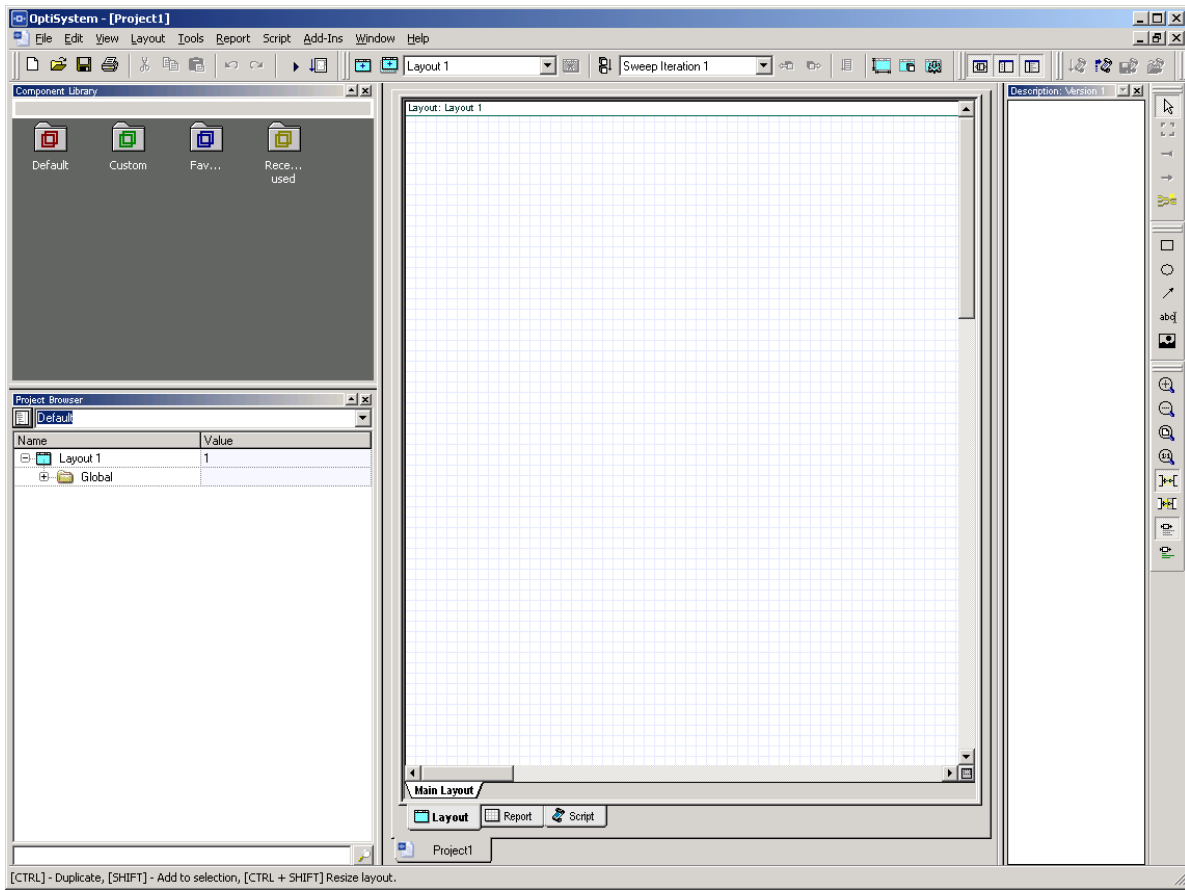
### Action

- From the **Start** menu, select **Programs > Optiwave Software > OptiSystem 12 > OptiSystem**.  
*OptiSystem loads and the graphical user interface appears (see [Figure 1](#)).*



# QUICK START

Figure 1 OptiSystem graphical user interface (GUI)



## Main parts of the GUI

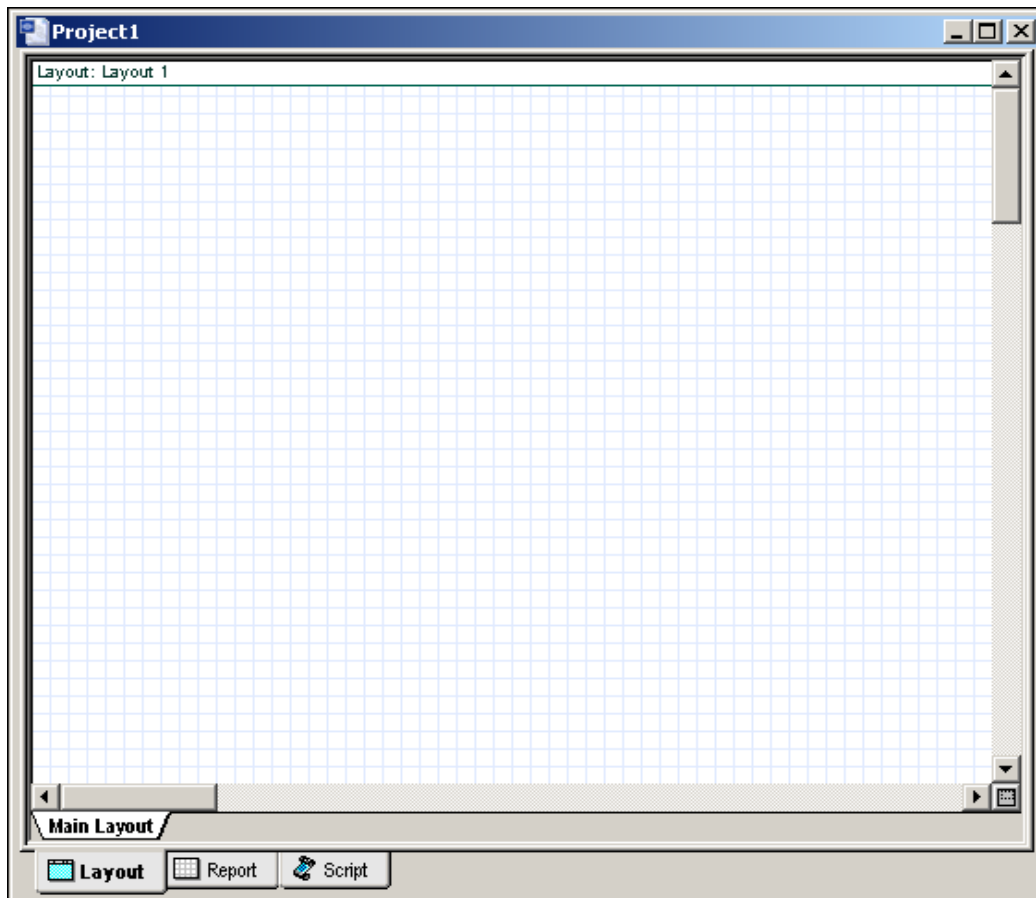
The OptiSystem GUI contains the following main windows:

- [Project layout](#)
- [Dockers](#)
  - [Component Library](#)
  - [Project Browser](#)
  - [Description](#)
- [Status Bar](#)

### Project layout

The main working area where you insert components into the layout, edit components, and create connections between components (see [Figure 2](#)).

**Figure 2** Project layout window



## Dockers

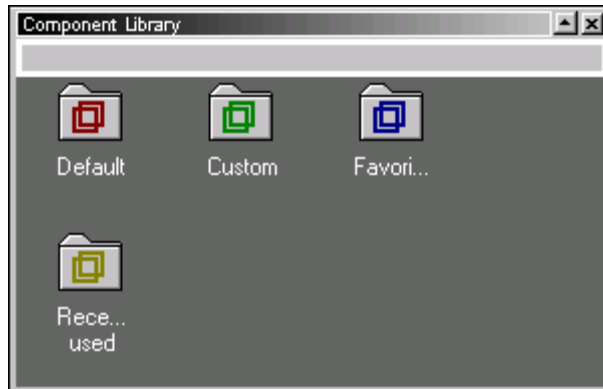
Use dockers, located in the main layout, to display information about the active (current) project:

- [Component Library](#)
- [Project Browser](#)
- [Description](#)

### Component Library

Access components to create the system design (see [Figure 3](#)).

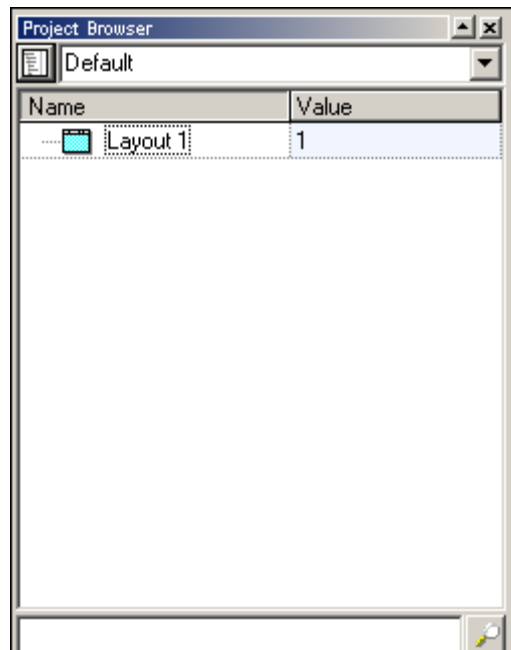
**Figure 3 Component Library window**



### Project Browser

Organize the project to achieve results more efficiently, and navigate through the current project (see [Figure 4](#)).

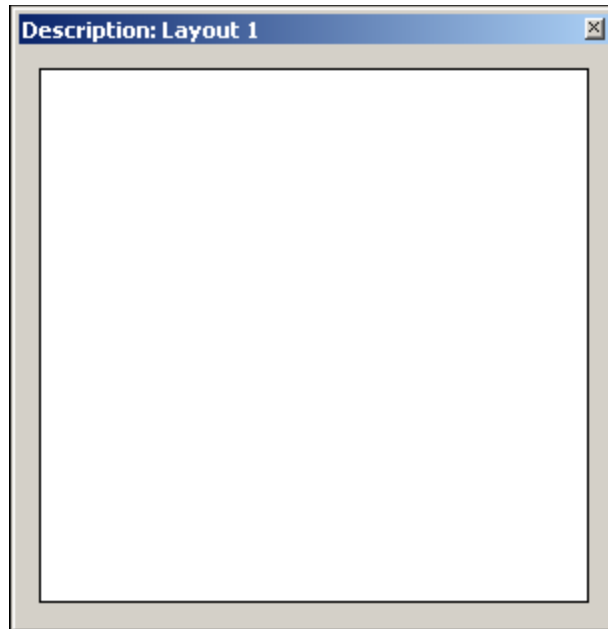
**Figure 4 Project Browser window**



**Description**

Display detailed information about the current project (see [Figure 5](#)).

**Figure 5** Description window

**Status Bar**

Displays project calculation progress information, useful hints about using OptiSystem, and other help. Located at the bottom of the **Project Layout** window.

**Figure 6** Status Bar

[CTRL] - Duplicate, [SHIFT] - Add to selection, [CTRL + SHIFT] Resize layout.



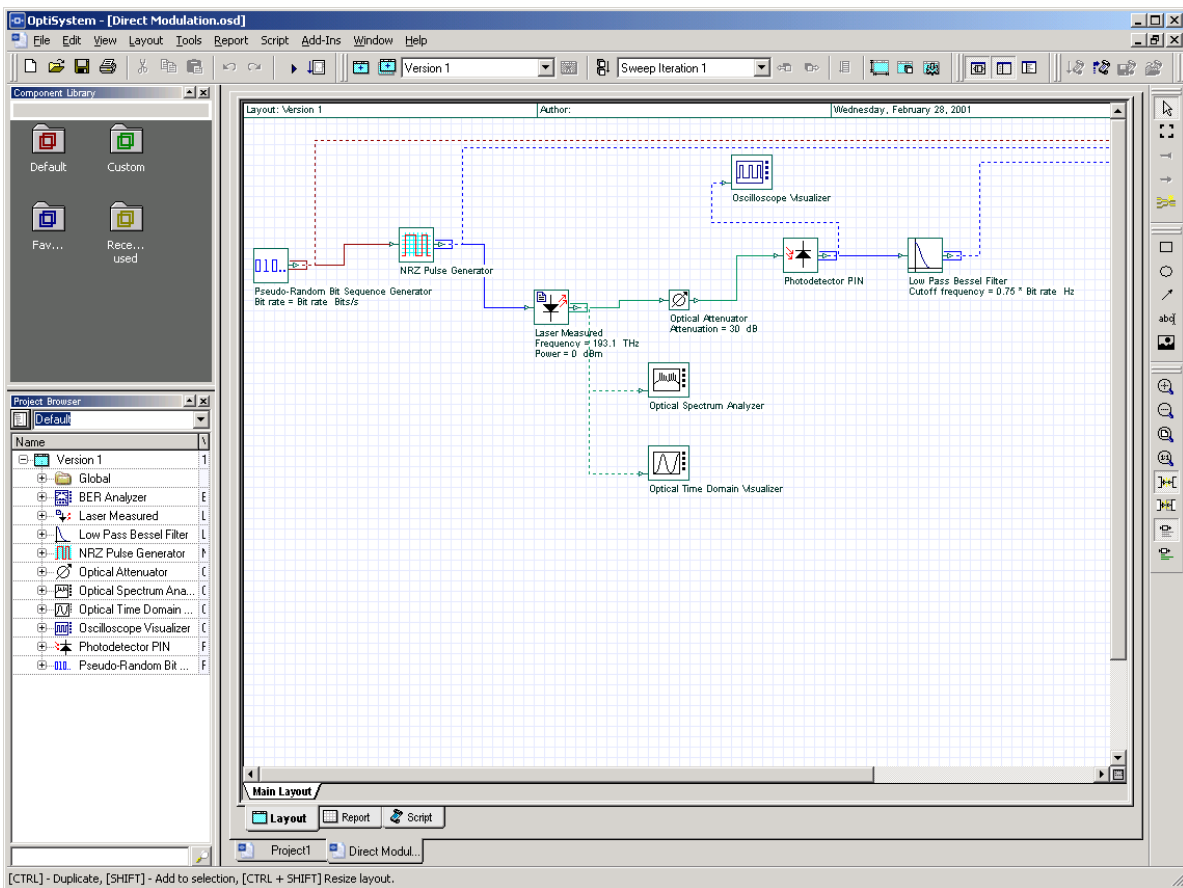
### Loading a sample file

To load a sample file, perform the following procedure.

**Step Action**

- 1 From the **File** menu, select **Open**.
- 2 In **Samples > Introductory Tutorials**, select **Quick Start Direct Modulation.osd**.  
*The **Direct Modulation** sample file appears in the **Main layout** (see [Figure 7](#)).*

**Figure 7 Direct Modulation sample file**



The transmitter is built using a direct laser modulation scheme, and consists of the following components:

- **Pseudo-Random Bit Sequence Generator:** Sends the bit sequence to the **NRZ Pulse Generator**. The pulses modulate the **Laser Measured**. The **Photodetector PIN** receives the optical signal attenuated by the **Optical Attenuator**. The **Low Pass Bessel Filter** filters the electrical signal.
- **Optical Spectrum Analyzer:** Displays the modulated optical signal in the frequency domain



- **Optical Time Domain Visualizer:** Displays the modulated optical signal in the time domain.
- **Oscilloscope Visualizer:** Displays the electrical signal after the PIN in time domain.
- **BER Analyzer:** Measures the performance of the system based on the signal before and after the propagation.

**Note:** More than one visualizer can be attached to a component output.

### Running a simulation

To run a simulation, perform the following procedure.

#### Step Action

- 1 From the **File** menu, select **Calculate** (see [Figure 8](#)).  
*The **OptiSystem Calculations** dialog box appears (see [Figure 9](#)).*

**Figure 8 File menu**

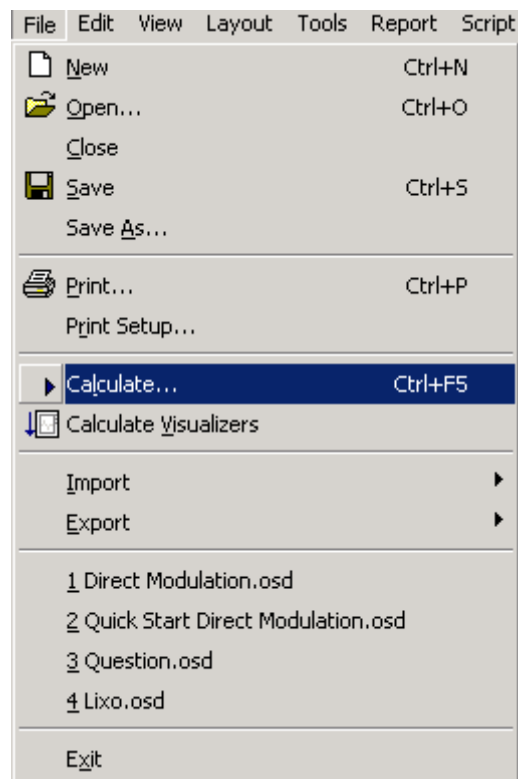
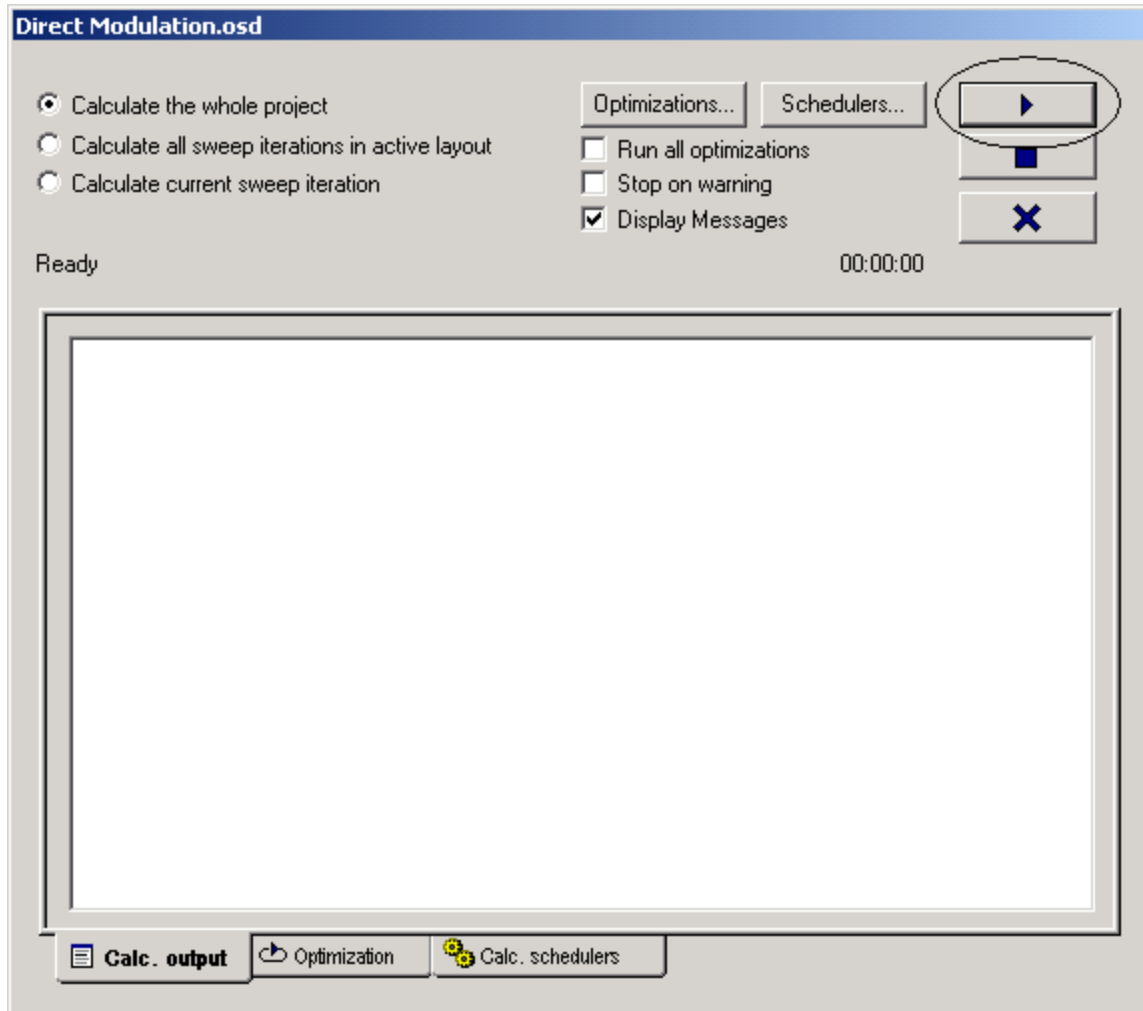


Figure 9 OptiSystem Calculations dialog box



- 2 In the **OptiSystem Calculations** dialog box, click the **Run** button (see [Figure 9](#)).  
*The results appear in the **Calculation Output** window.  
 The calculation output appears in the **Calculation Output** window, and the simulation results appear below the components that were included in the simulation.*



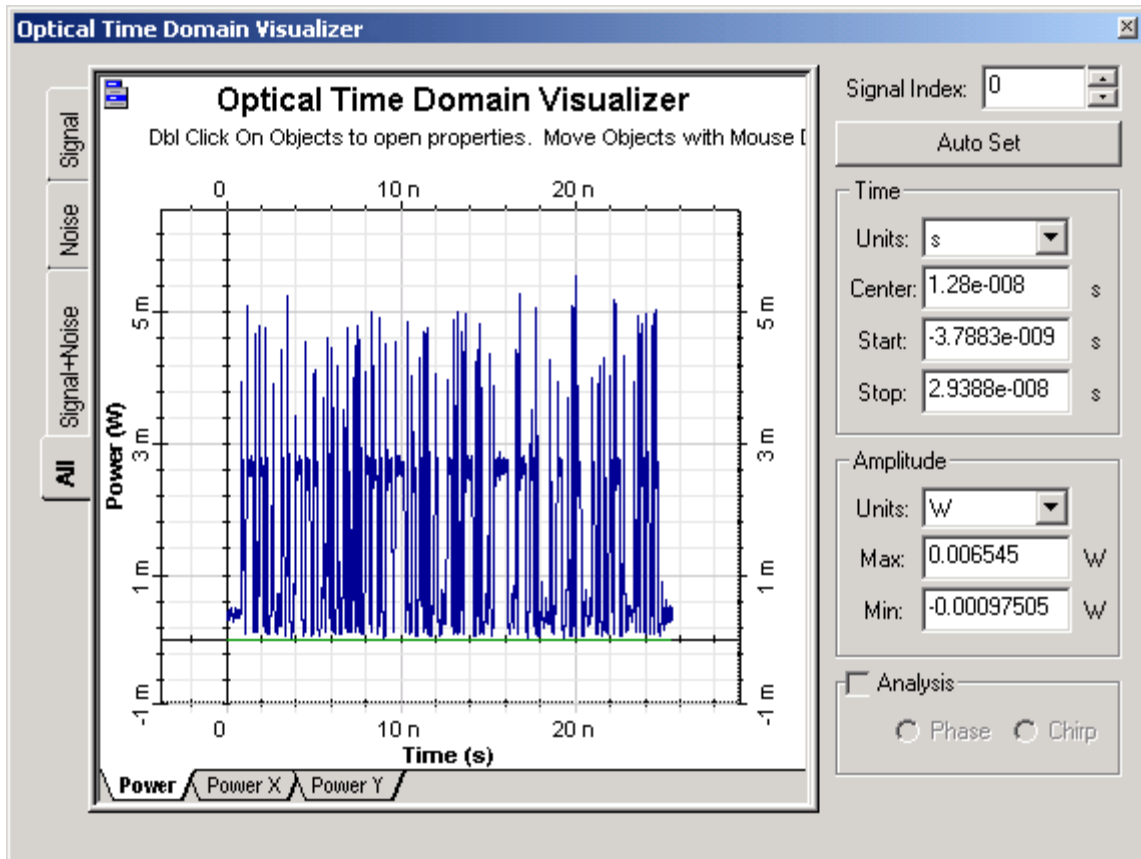
### Displaying results from a visualizer

To view the simulation results, perform the following action.

#### Action

- Double-click a visualizer in the **Project layout** to view the graphs and results that the simulation generates (see [Figure 10](#)).

Figure 10 Optical Time Domain Visualizer results



## Component parameters

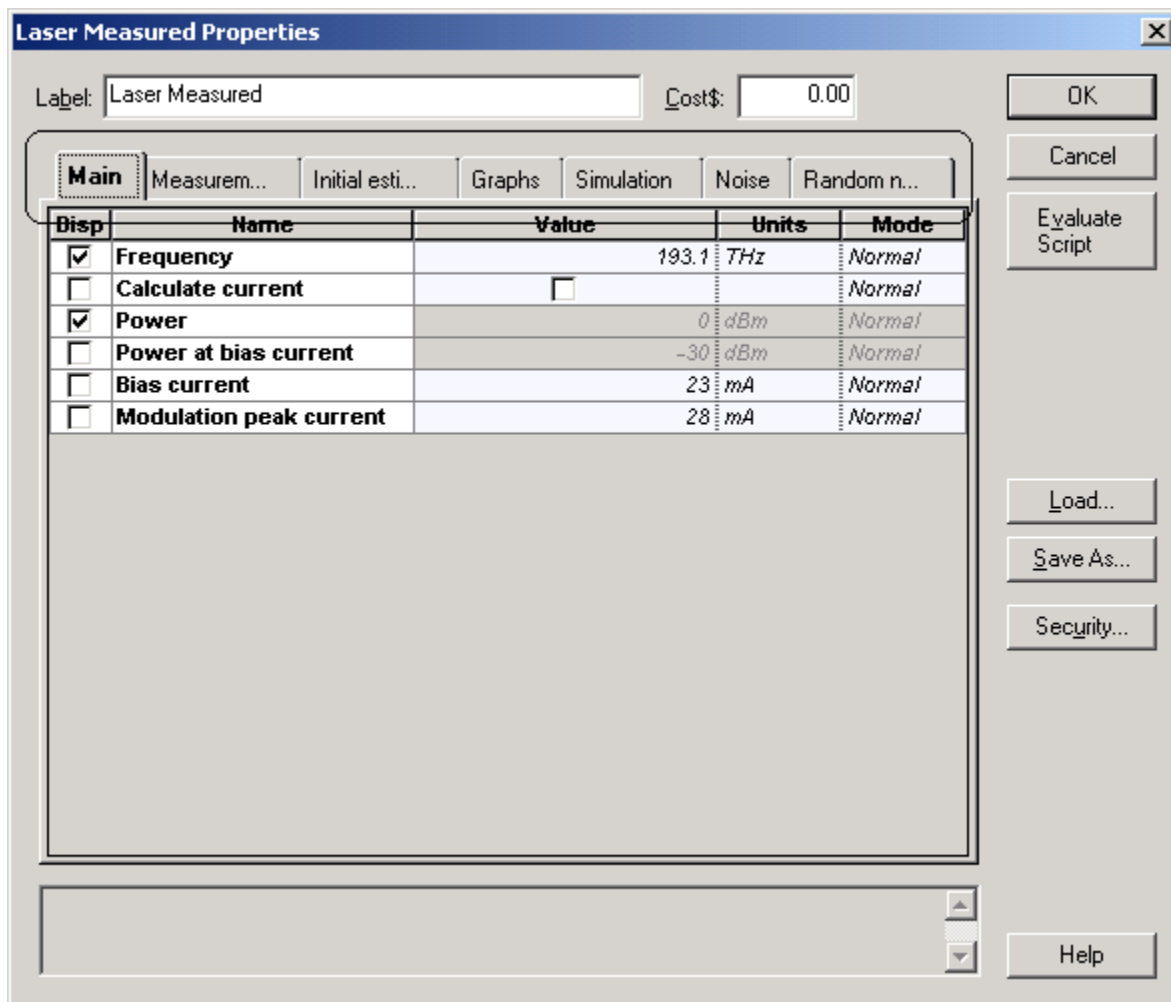
### *Viewing and editing component parameters*

Double-click a component to view and edit the parameters for the component. To view the properties for **Laser Measured**, perform the following action.

#### Action

- In the **Project layout**, double-click the **Laser Measured** component. *The **Laser Measured Properties** dialog box appears.*

Figure 11 Component parameters – Laser Measured



Component parameters are organized by categories. **Laser Measured** has seven parameter categories, each represented by a tab in the dialog box (see [Figure 11](#)).

- Main
- Measurements
- Initial estimate
- Numerical
- Graphs
- Simulation
- Noise
- Random numbers

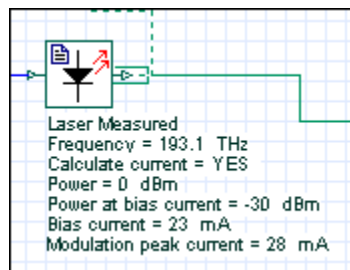
Each category has a set of parameters. Parameters have the following properties:

- Disp
- Name
- Value
- Units
- Mode

The first category in the **Laser Measured** dialog box is **Main**. You can enter the signal **Frequency** and **Power** using the **Main** tab.

The first parameter in the **Main** category is **Disp**. When you select a check box beside a parameter listed in the **Disp** column, the parameter value appears under the component in the **Project layout**. For example, if you select the **Frequency** and **Power** check boxes in the **Disp** column, these parameter values appear in the **Project layout** (see [Figure 12](#)).

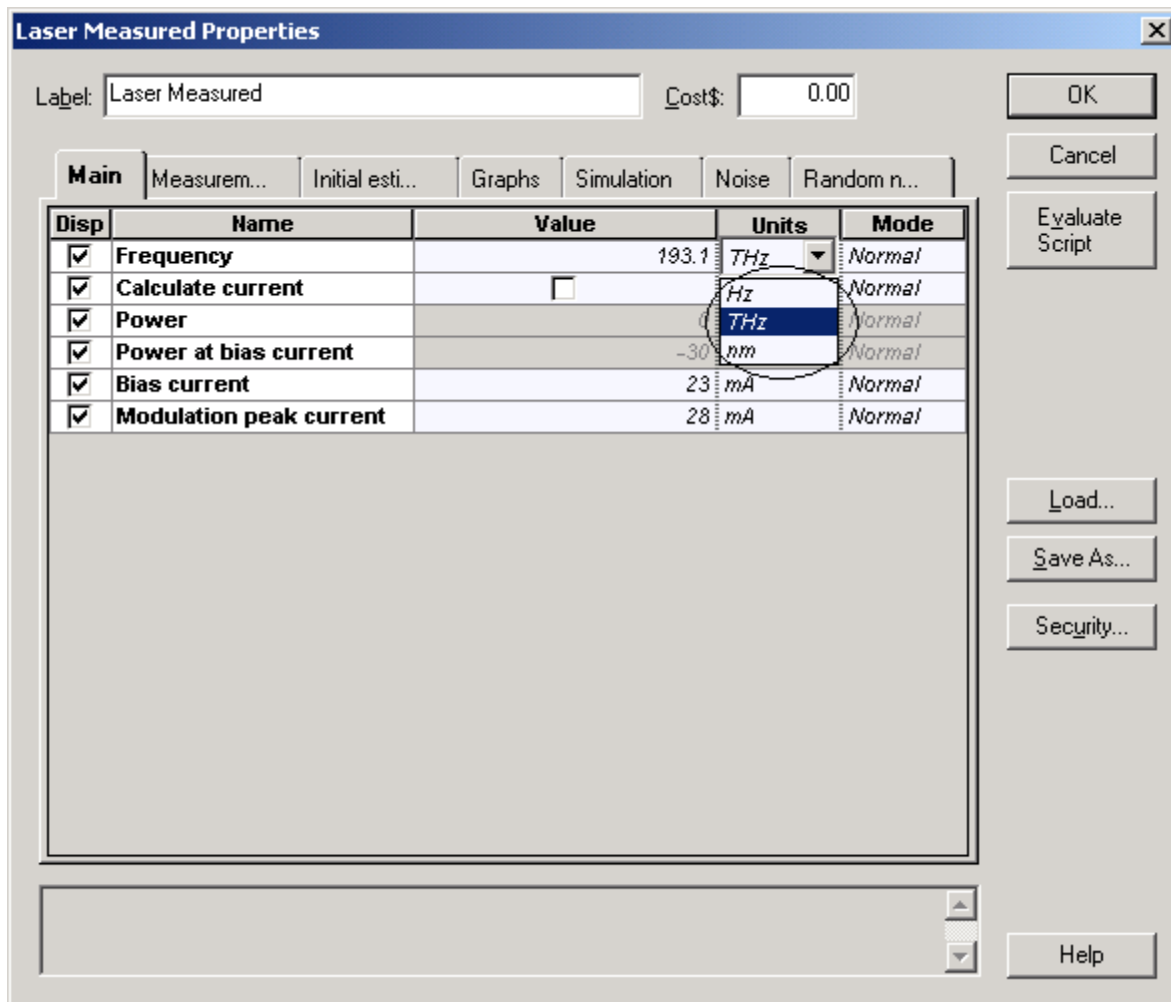
**Figure 12 Laser Measured with displayed parameter values**



Each parameter can have a value in the columns **Name**, **Value**, **Units**, and **Mode**. Some parameters can have different units. For example, you can select the **Frequency** parameter to be in Hz, THz, or nm. When you change your unit selection, the conversion is automatic (see [Figure 13](#)).



Figure 13 Choosing parameter values



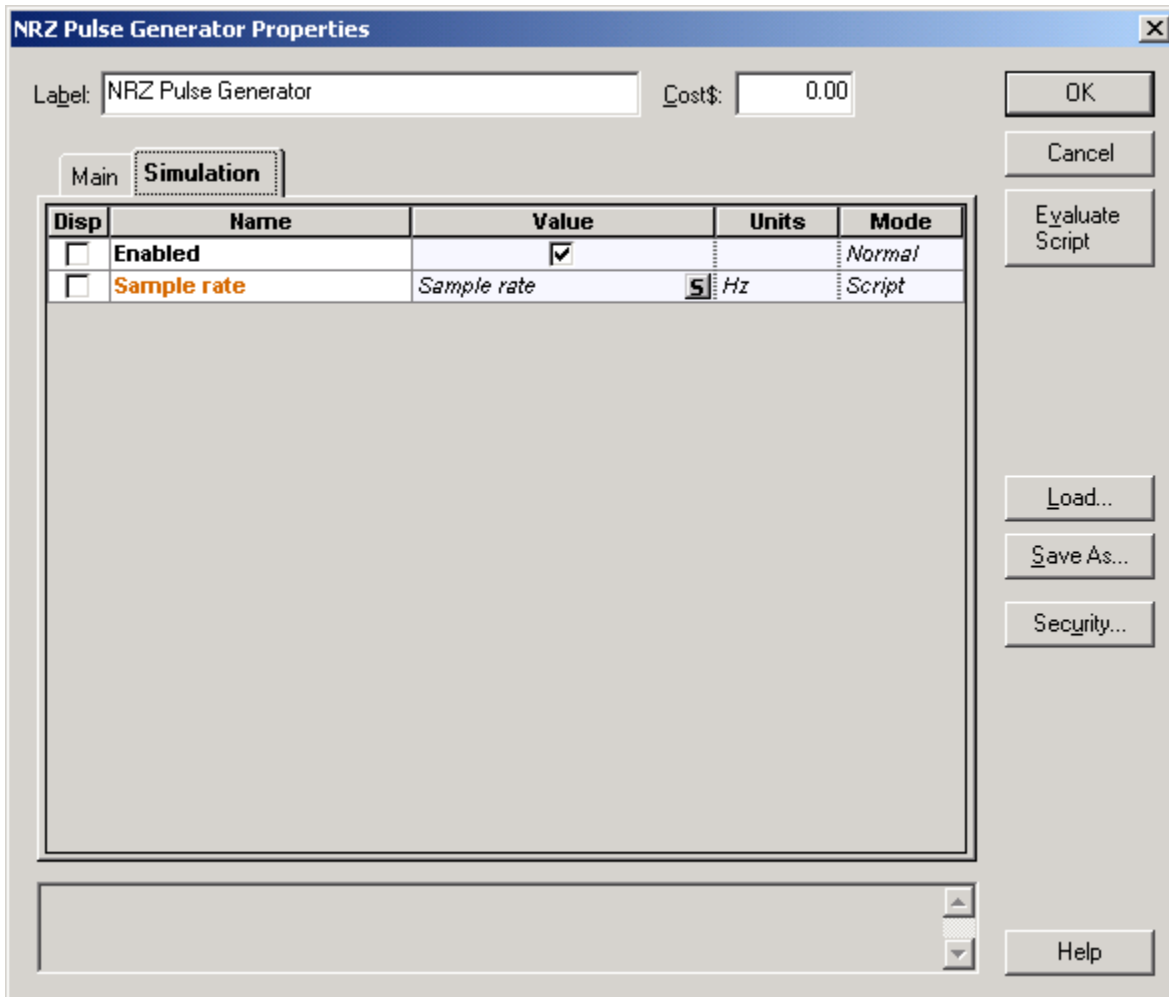
## Editing parameters

To edit the **NRZ Pulse Generator** parameters, perform the following procedure.‘

### Step Action

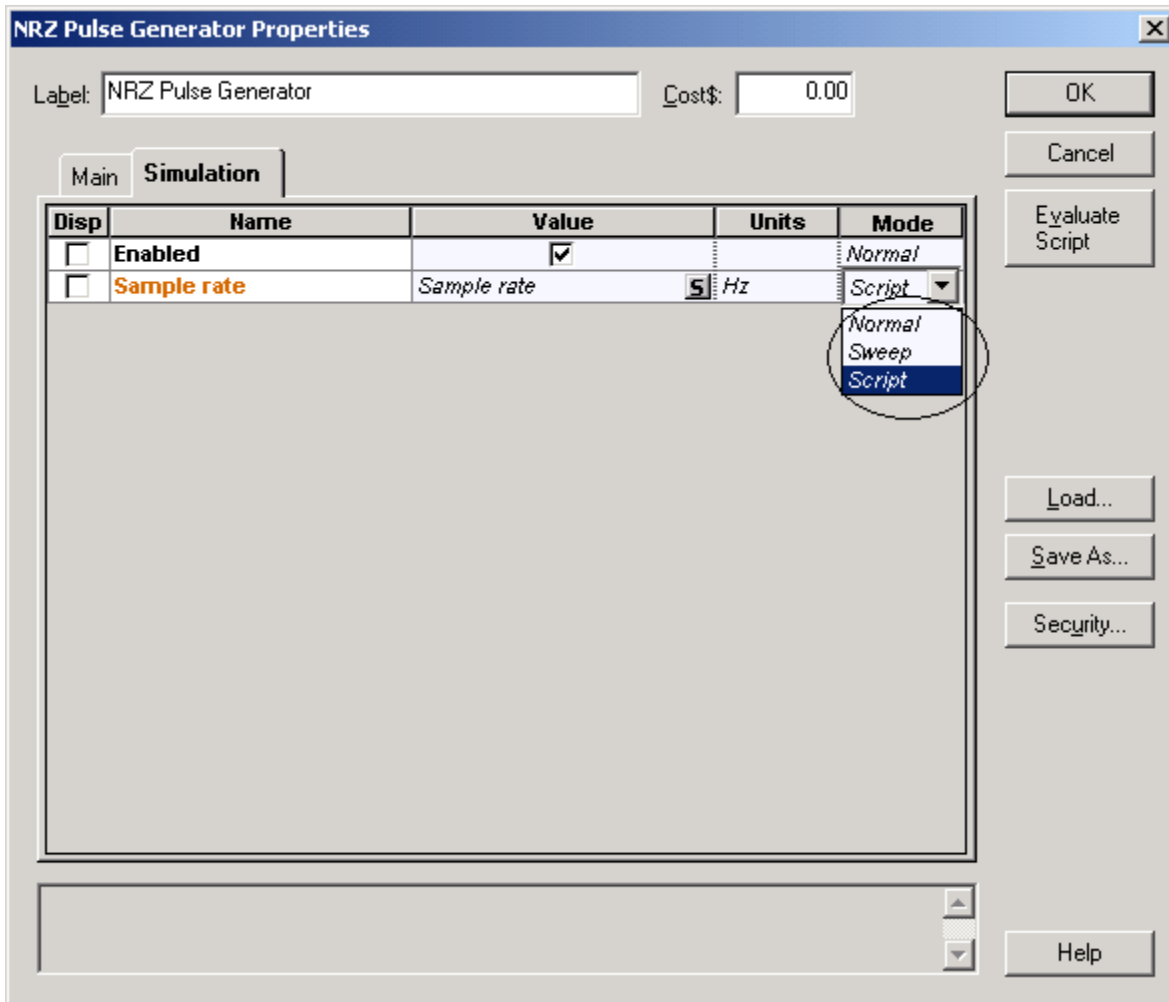
- 1 Double-click the **NRZ Pulse Generator** in the **Project layout**.  
*The **NRZ Pulse Generator Properties** dialog box appears (see [Figure 14](#)).*
- 2 Click the **Simulation** tab.

Figure 14 Laser NRZ Pulse Generator simulation options



For the **Sample rate** parameter, the **Mode** is **Script** (see Figure 15). This parameter will be evaluated as an arithmetic expression. The **Sample rate** parameter of the **Laser Measured** component also refers to a Global parameter with the same name.

Figure 15 Scripted parameters

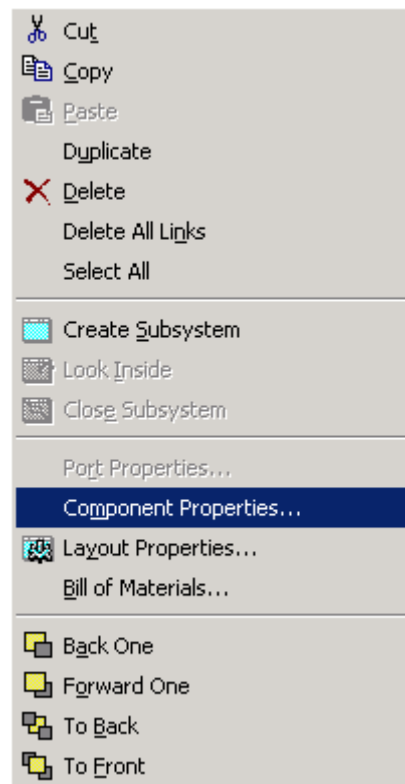


## Editing visualizer parameters

To access the parameters for the **Optical Spectrum Analyzer**, perform the following procedure.

- | Step | Action  |
|------|---|
| 1    | Right-click the <b>Optical Spectrum Analyzer</b> .<br><i>A shortcut menu appears (see <a href="#">Figure 16</a>).</i> |

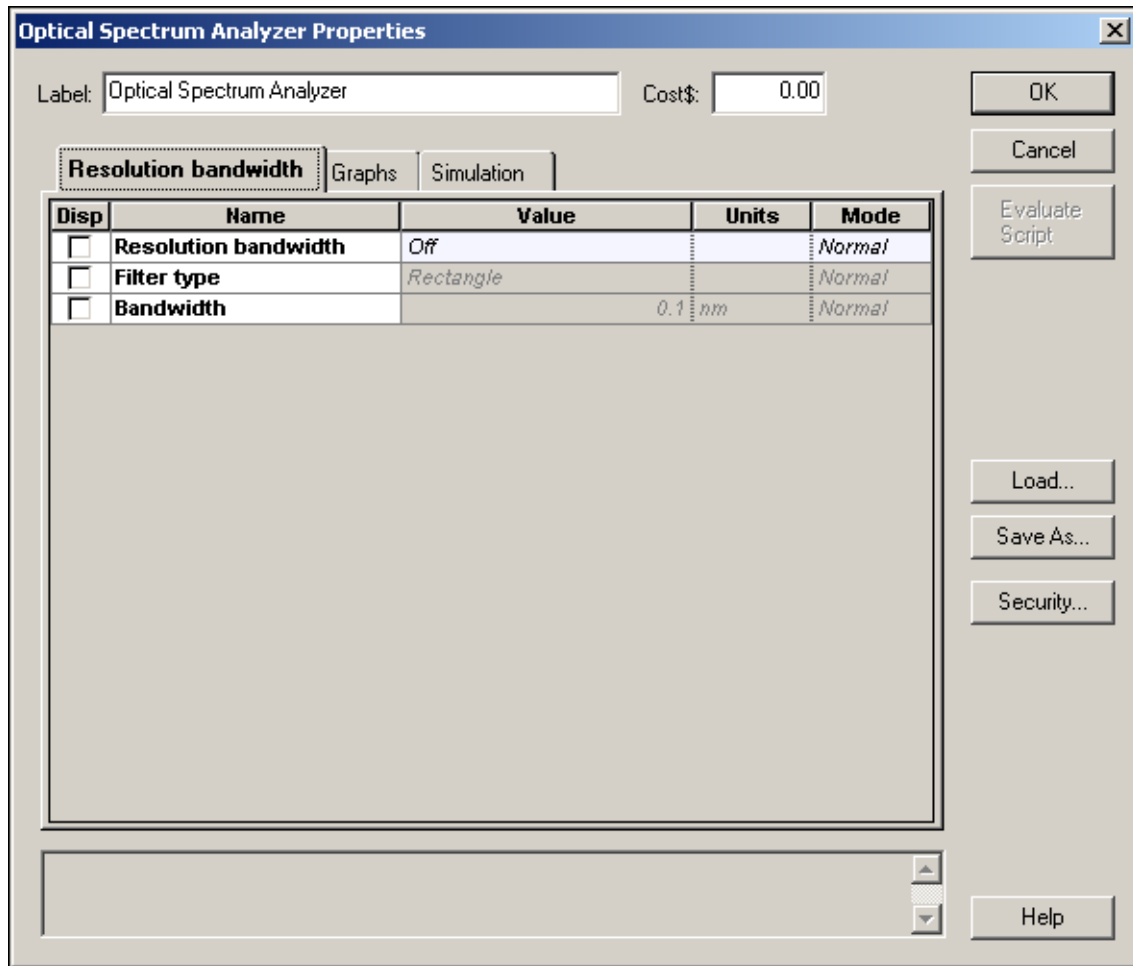
**Figure 16** Shortcut menu



- |   |  |
|---|--|
| 2 | Select <b>Component Properties</b> .<br><i>The <b>Optical Spectrum Analyzer Properties</b> dialog box appears (see <a href="#">Figure 17</a>).</i> |
|---|--|



Figure 17 Optical Spectrum Analyzer Properties dialog box





## Global parameters

The global parameters are common to all OptiSystem simulations. (See [Appendix A: Global Parameters](#) for more information on global parameters.) In this particular case, you indirectly define the simulation time window, the number of samples, and the sample rate using three parameters:

- Bit rate
- Bit sequence length
- Number of samples per bit

These parameters are used to calculate the **Time window**, **Sample rate**, and **Number of samples**.

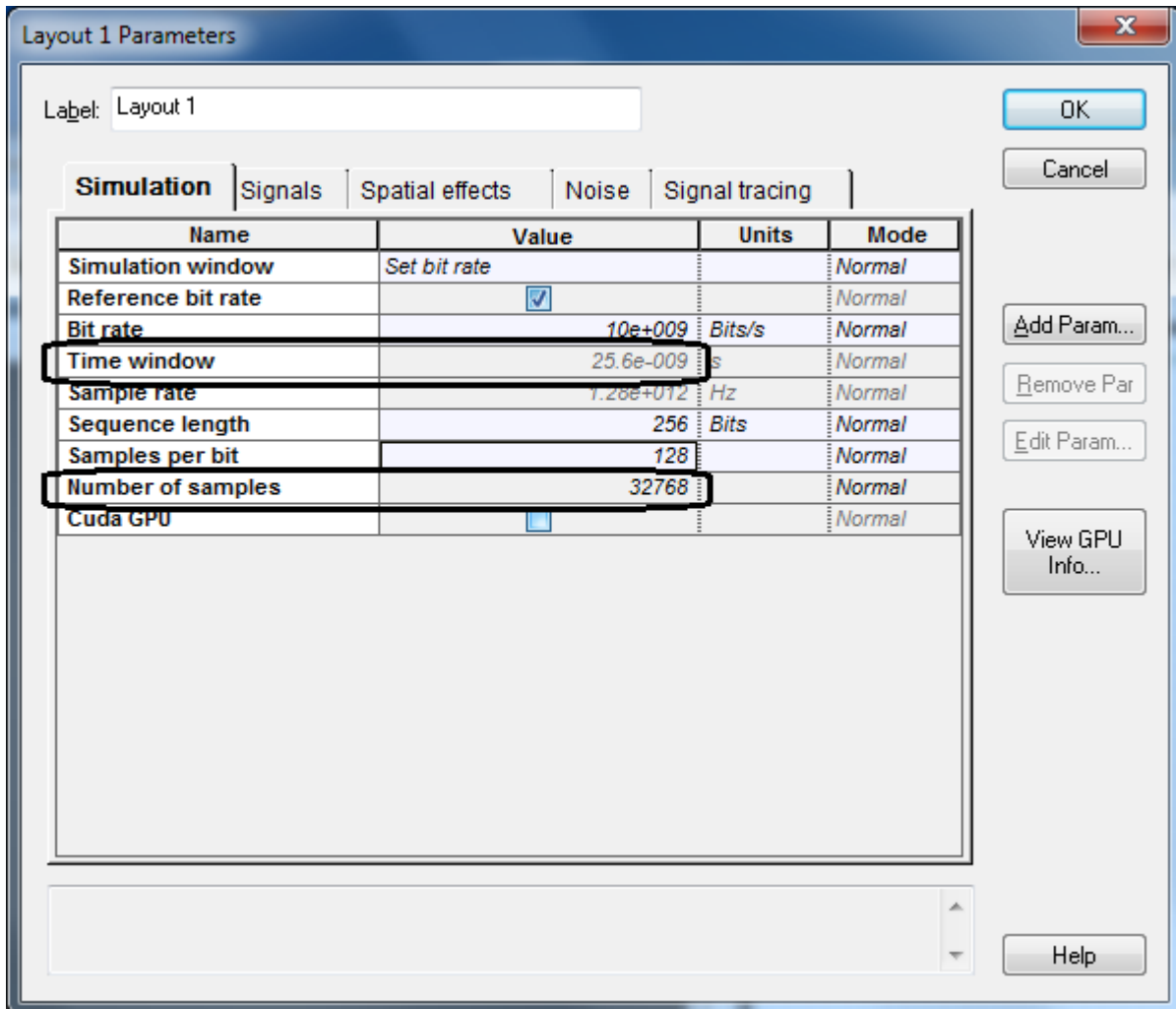
- **Time window** = Sequence length \* 1/Bit rate =  $256 * 1 / 10e9 = 25.6 \text{ ns}$
- **Number of samples** = Sequence length \* Samples per bit = 32768 samples
- **Sample rate** = Number of samples / Time window = 1.28 THz

The time window of the simulation is 25.6 ns. 32768 samples will be generated by each component, and the signal bandwidth is 1.28 THz.

OptiSystem shares the parameter **Time window** with all components. This means that each component works with the same time window. However, each component can work with different sample rates or number of samples (see [Figure 18](#)).



Figure 18 Global parameters values



## Editing global parameters

To edit global parameters, perform the following procedure.

### Step Action

- 1 Double-click in the **Project layout**.  
The **Layout 1 Parameters** dialog box appears (see [Figure 18](#)).
- 2 Select or clear global parameters as required.

These parameters can be accessed by any component using the script mode. The **NRZ Pulse Generator** refers by default to the global parameter **Sample rate** using script mode (see [Figure 19](#)). The **Low Pass Bessel Filter** has the Cutoff parameter frequency as  $0.75 * \text{Bit rate}$ . In this case, **Bit rate** is a global parameter (see [Figure 20](#)).

Figure 19 NRZ Pulse Generator properties

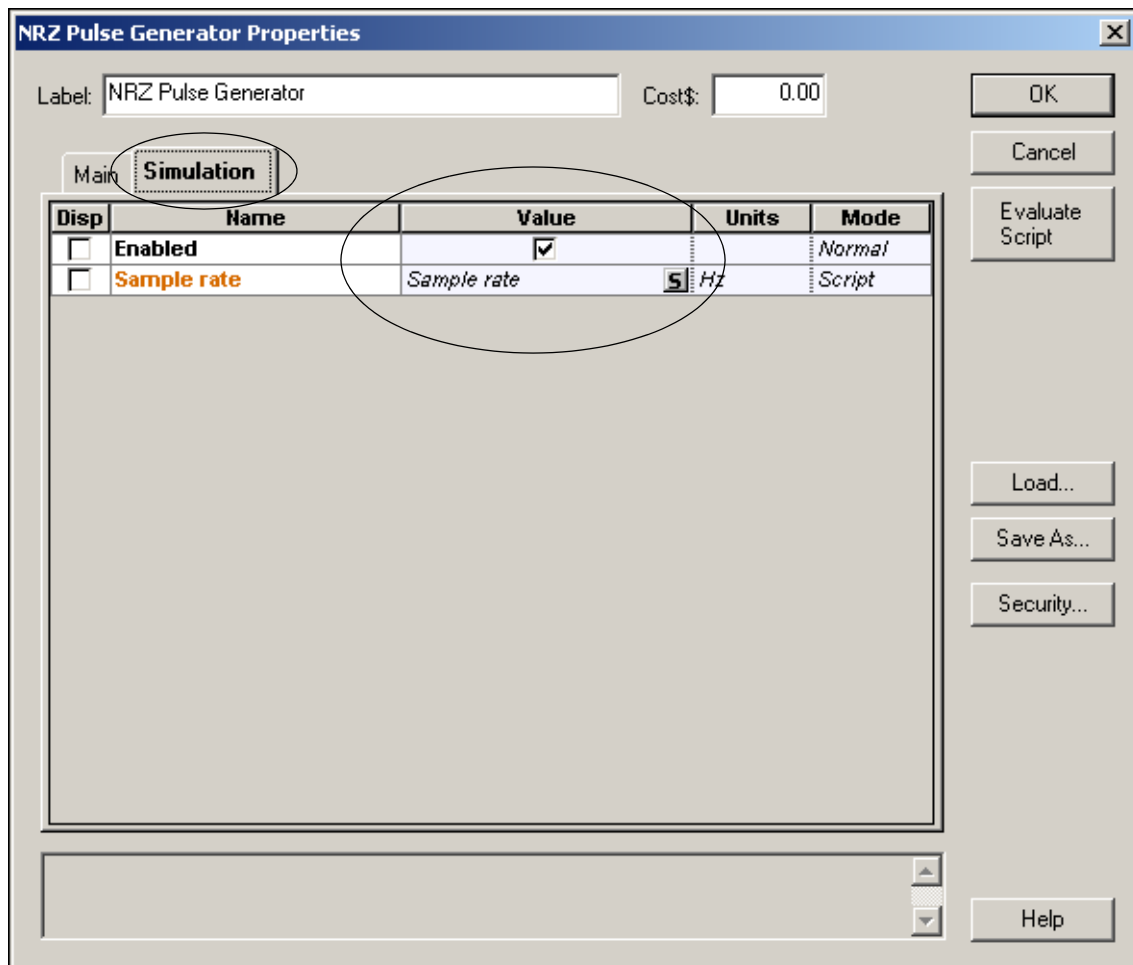
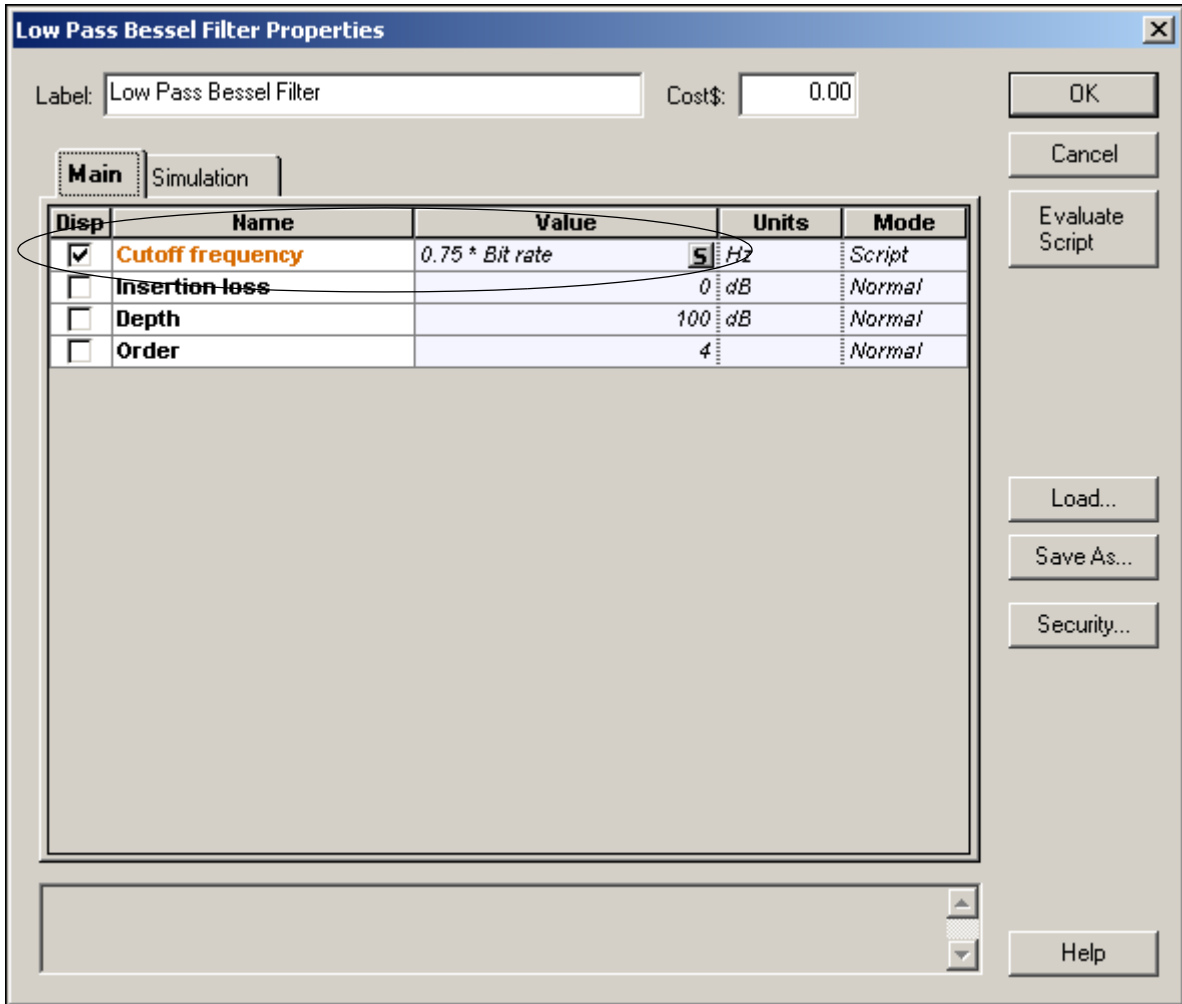


Figure 20 Low Pass Bessel Filter properties



## Using the Layout Editor

In the following example, you will modify a design that you create. You will change the laser modulation scheme from direct to external modulation by replacing some of the components in the design and adding components from the Component Library.

To use the **Layout Editor**, perform the following procedure.

### Step Action

- 1 To delete the **Laser Measured** component, select the **Laser Measured** component in the **Project layout** and press the **Delete** key.

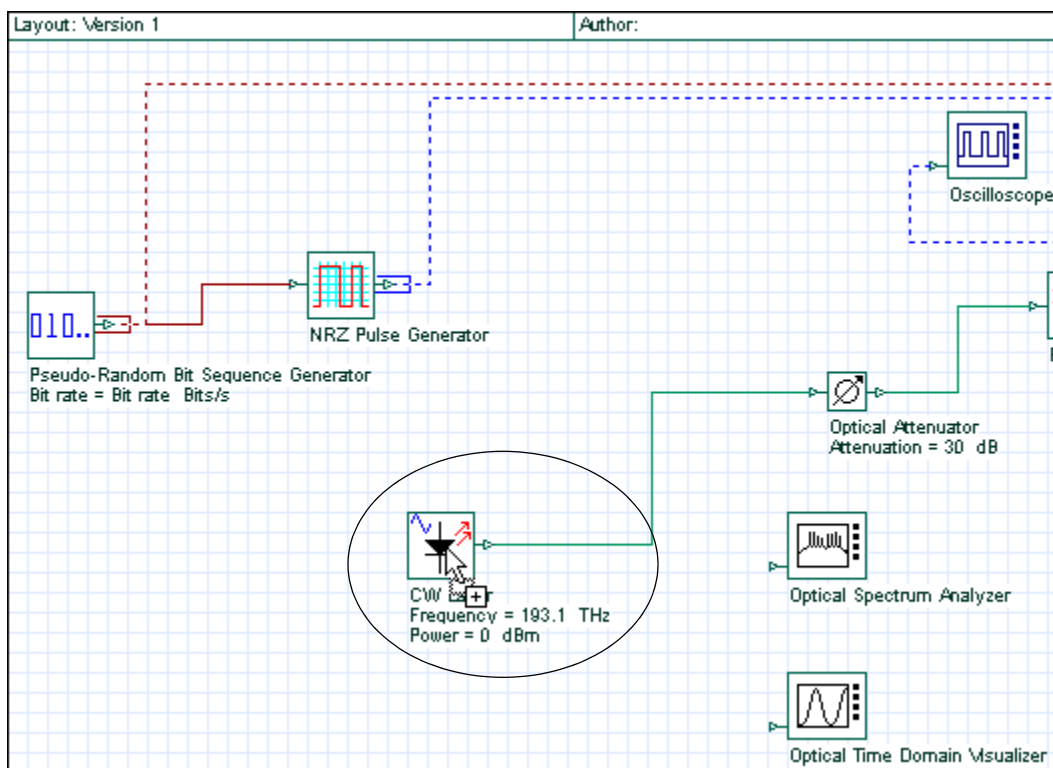
*The **Laser Measured** component is deleted from the layout.*

- 2 From the Component Library, select **Default > Transmitters Library > Optical Sources**.

- 3 Drag the **CW Laser** to the **Project layout** (see [Figure 21](#)).

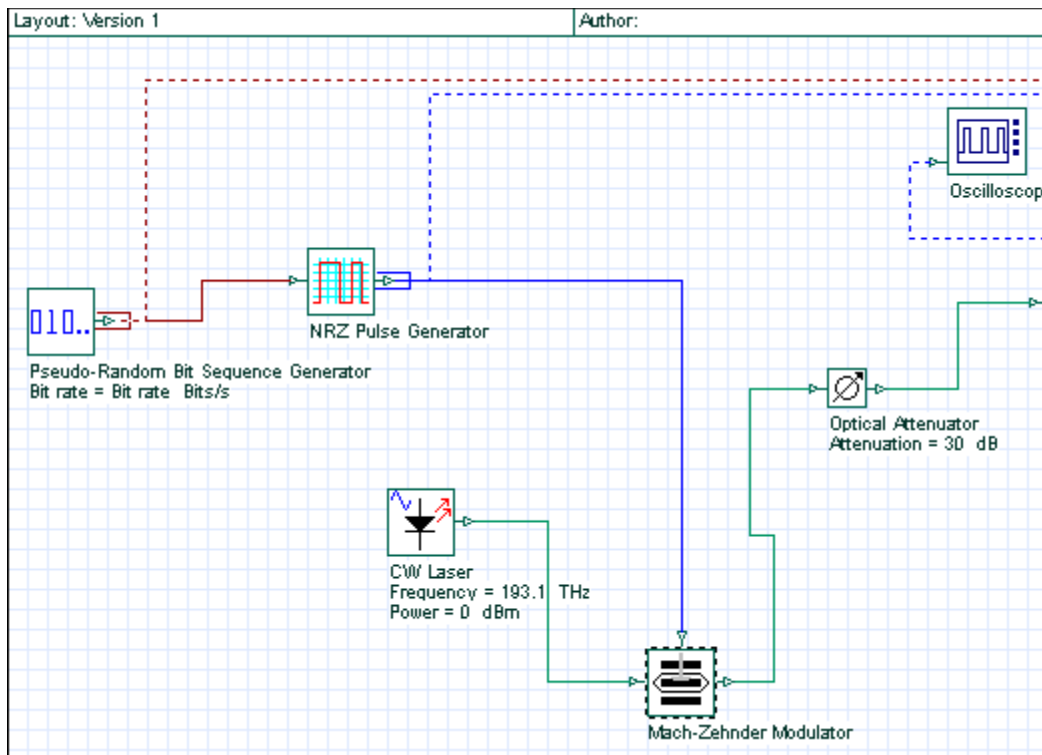
**Note:** The autoconnect feature automatically connects components in the **Project layout**. If connections are not made automatically, see “Connecting components manually” on page 31.

**Figure 21** CW Laser added to Main Layout



- 4 From the Component Library, select **Default > Transmitters Library > Optical Modulators**.
- 5 Drag the **Mach-Zehnder Modulator** to the **Project layout** (see [Figure 22](#)).
- 6 Place the **Mach-Zehnder Modulator** in the **Project layout** so the following connections are generated:
  - a. **NRZ Pulse Generator** output port to the **Mach-Zehnder** modulation input port
  - b. **CW Laser** output port to the **Mach-Zehnder Modulator** Carrier input port
  - c. **Mach-Zehnder Modulator** output port to the **Optical Attenuator** input port

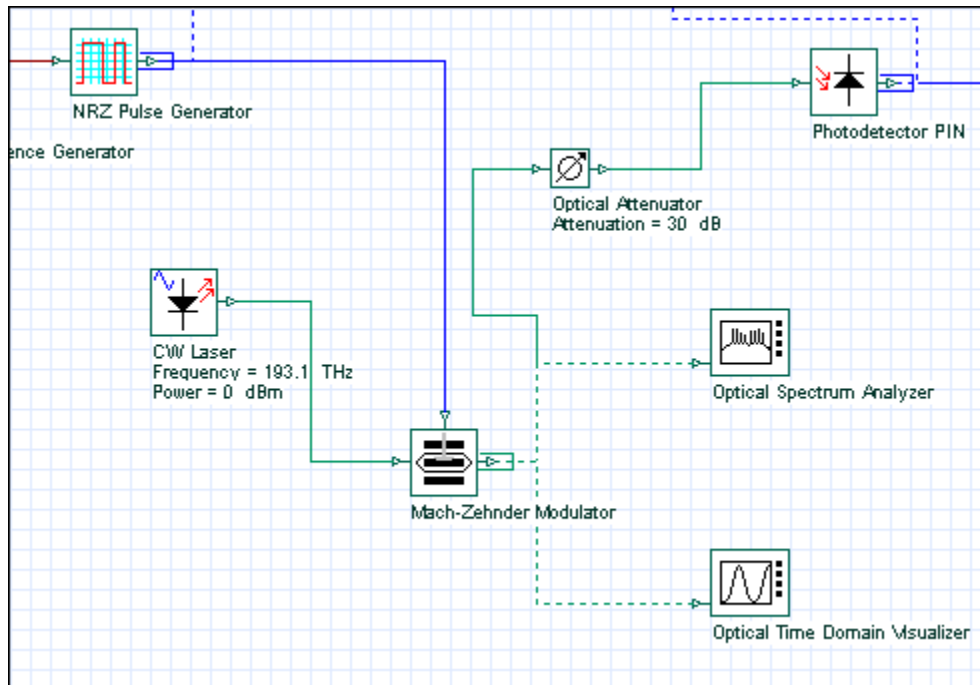
Figure 22 Connecting components



- 7 Connect the **Mach-Zehnder Modulator** output port to the **Optical Spectrum Analyzer** input port and to the **Optical Time Domain Visualizer** input port (see [Figure 23](#)).



Figure 23 Mach-Zehnder Modulator connected to visualizers



- 8 From the **File** menu, select **Calculate**.  
*The **OptiSystem Calculations** dialog box appears.*
- 9 Click the **Run** button.  
*The results appear in the **Calculation Output** window.*
- 10 To view the graphs and results, double-click on the visualizers (see [Figure 25](#) and [Figure 26](#) for examples of visualizer results).

### Connecting components manually

To connect components using the layout tool, perform the following procedure.

#### Step Action

- 1 Place the cursor over the initial port.  
*The cursor changes to the rubber band cursor (chain link) (see [Figure 24](#)).  
A tool tip appears that indicates the type of signal that is available on this port.*
- 2 Click and drag to the port to be connected.  
*The ports are connected.*

**Note:** You can only connect output to input ports and vice versa.

Figure 24 Rubber Band cursor



Figure 25 Visualizer results — OSA example

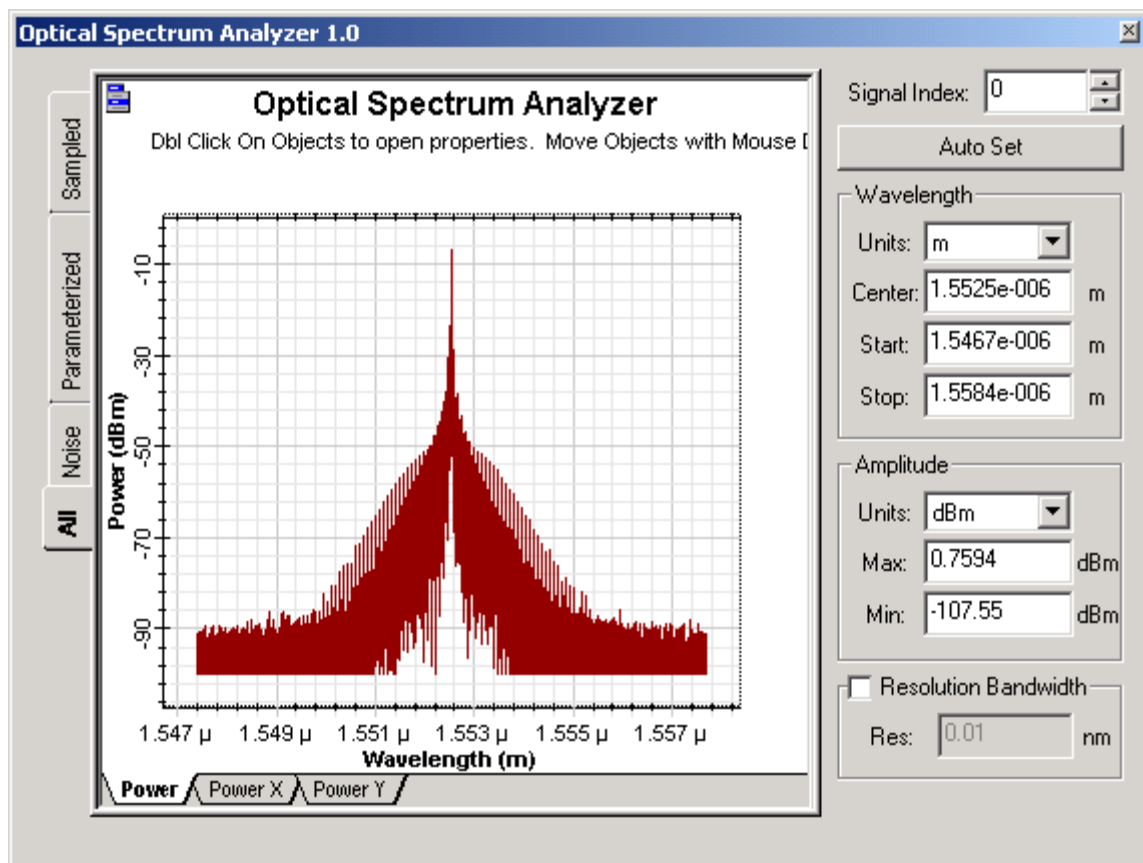
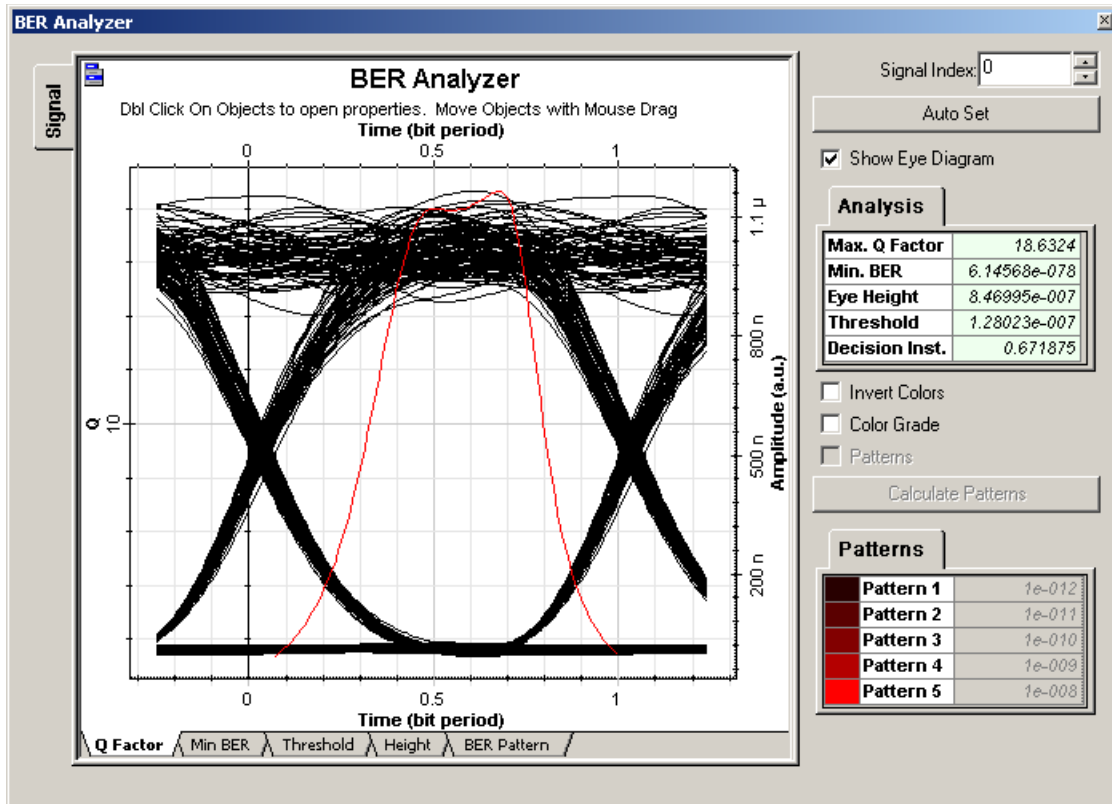




Figure 26 Visualizer results — BER example



### ***Saving the design and closing OptiSystem***

To save the design and close OptiSystem, perform the following procedure.

#### **Step Action**

- 1 From the **File** menu, select **Save**.  
*The Quick Start Direct Modulation.osd design is saved.*
- 2 From the **File** menu, select **Exit**.  
*OptiSystem closes.*



QUICK START

**Notes:**



# Appendix A: Global Parameters

---

## ***Opening the global parameters dialog***

To open the global parameters dialog, perform the following action.

### **Action**

- Double-click in the **Project layout** window.  
*The **Layout Parameters** dialog opens (see [Figure 27](#)).*

OR

- Select **Layout > Parameters** from the **Menu** tool bar.  
*The **Layout Parameters** dialog opens (see [Figure 27](#)).*

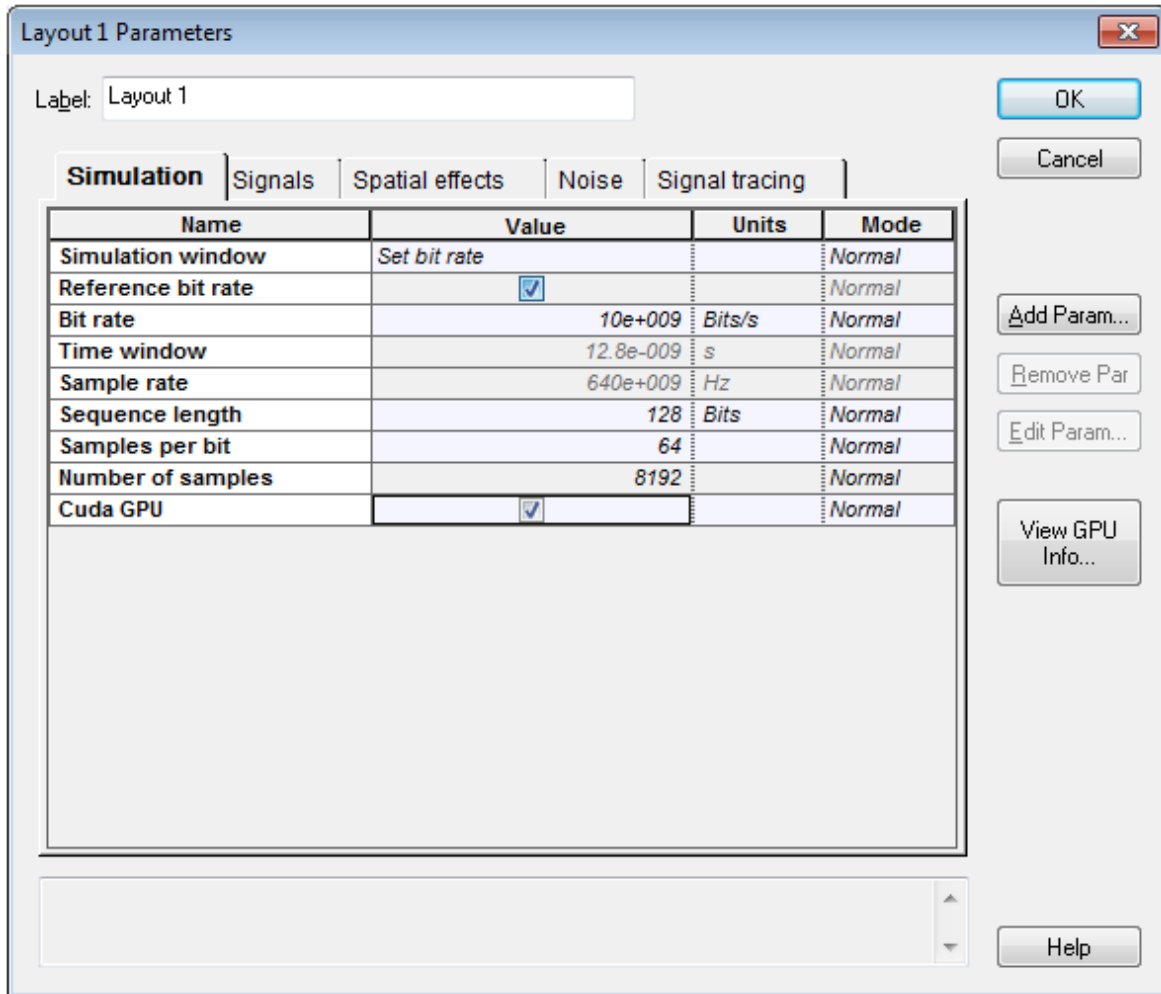
## ***Editing global parameters***

To edit global parameters, perform the following procedure.

### **Step    Action**

- 1**      Double-click in the **Project layout**.  
*The **Layout Parameters** dialog box appears (see [Figure 27](#)).*
- 2**      Select or clear global parameters as required.

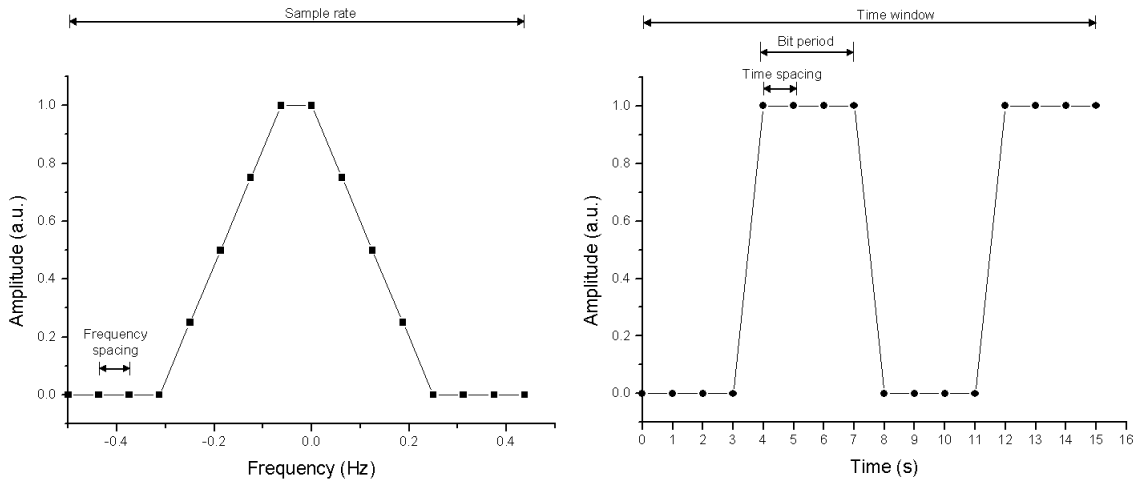
Figure 27 Layout Parameters dialog



When you create a new design, you must define the global simulation parameters. These parameters are critical to the simulation.

They show the speed, accuracy, and memory requirements for a particular simulation during the system design stage. It is important to understand what the global parameters are, because they have an impact on all the components that use these parameters (see [Figure 28](#)).

**Figure 28 Global parameters relationships**



$$\text{Time spacing} = 1 / \text{Sample rate} = \text{Time window} / \text{Number of samples}$$

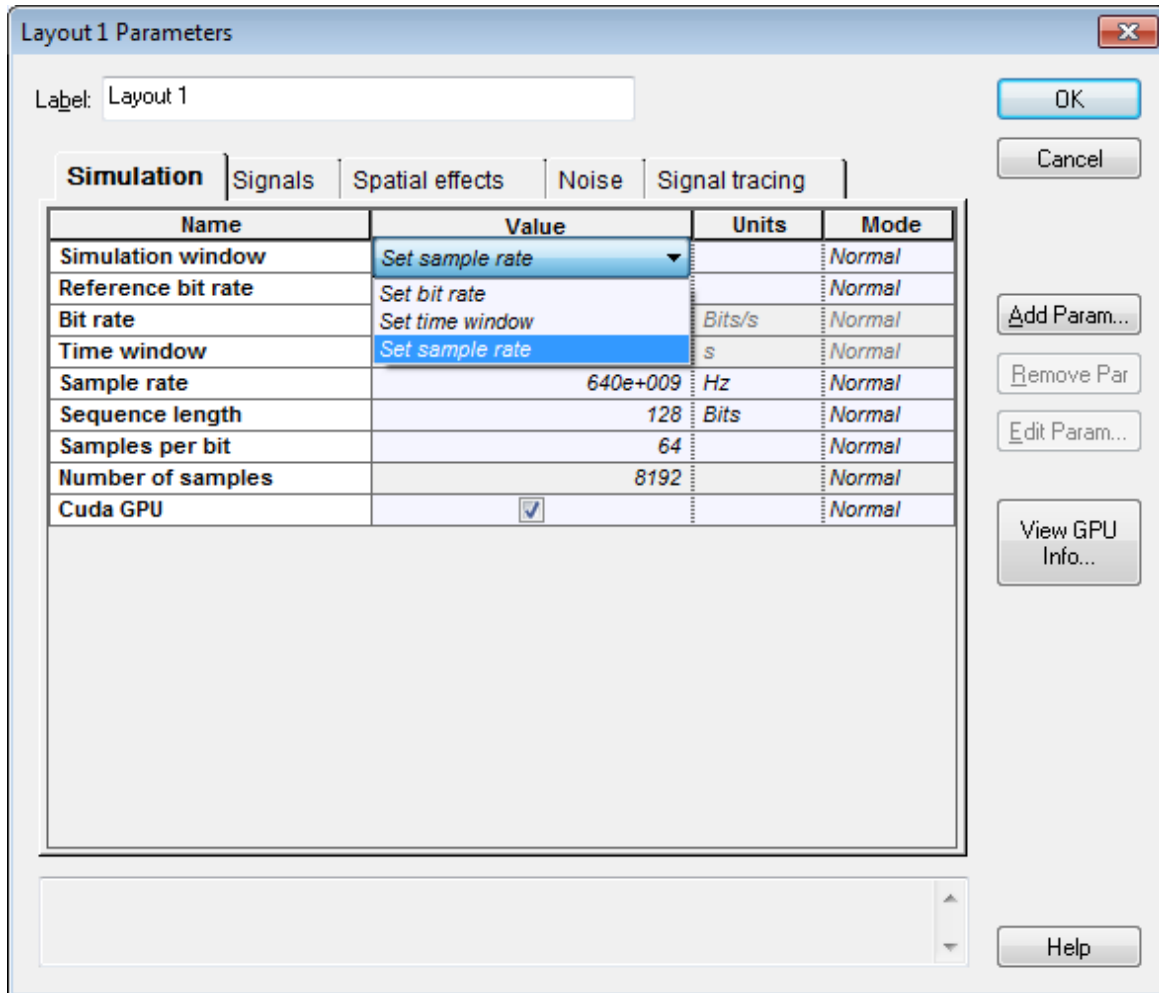
$$\text{Frequency spacing} = 1 / \text{Time window} = \text{Sample rate} / \text{Number of samples}$$

$$\text{Time window} = \text{Sequence length} * \text{Bit period} = \text{Sequence length} / \text{Bit rate}$$

$$\text{Number of samples} = \text{Sequence length} * \text{Samples per bit} = \text{Time window} * \text{Sample rate}$$

## Simulation parameters

Figure 29 Simulation parameters



### Simulation window

Specifies the setup mode for entering the parameters that define the main simulation parameters:

- **Set bit rate:** Allows you to enter the **Bit rate**. This is the default mode — you can easily set up the simulation using typical parameters such as **Bit rate**, **Sequence length**, and **Samples per bit**.
- **Set time window:** Allows you to enter the **Time window** value
- **Set sample rate:** Allows you to enter the **Sample rate**

The parameter **Bit rate** recalculates based on these parameters.



## Reference bit rate

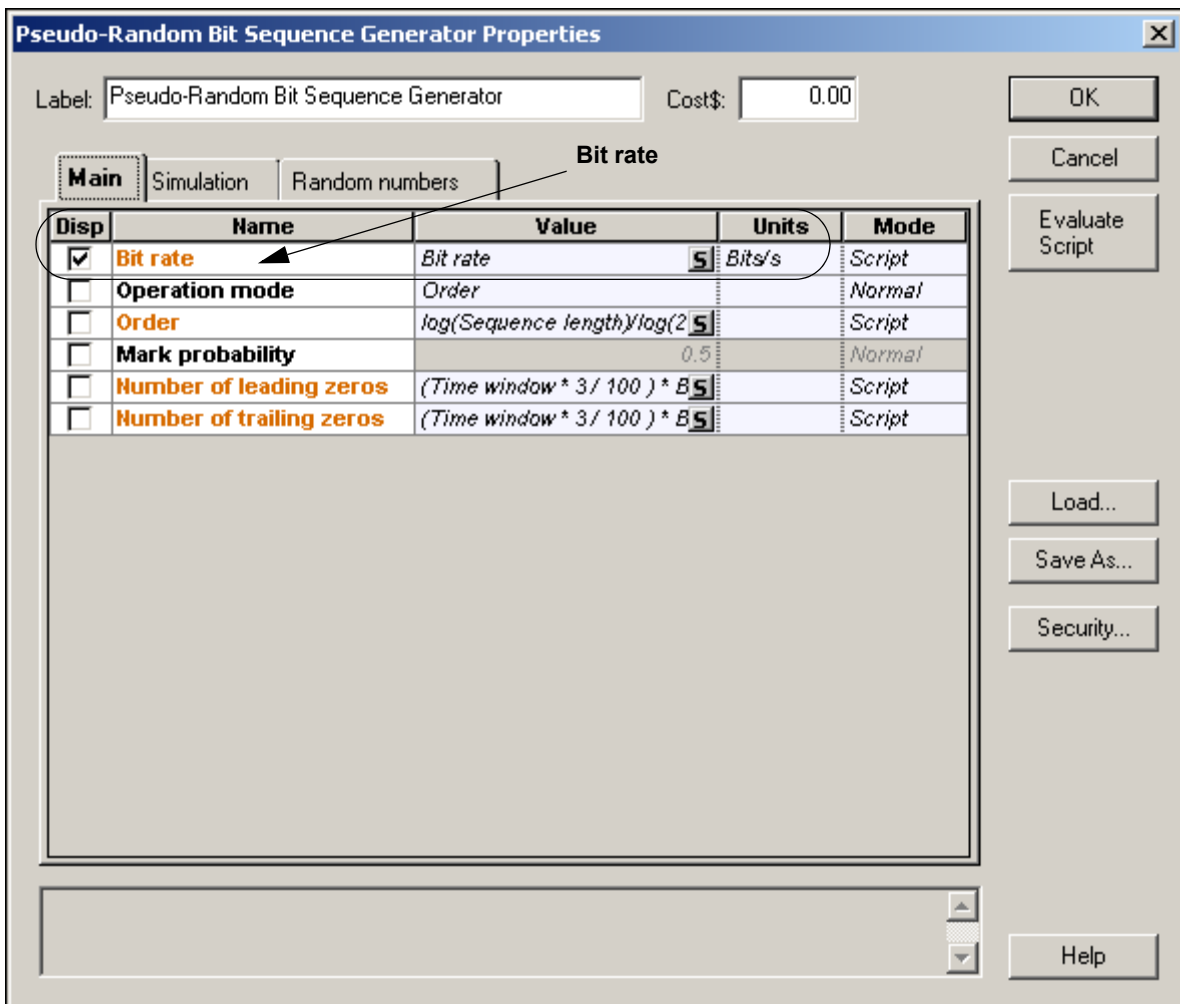
If this parameter is enabled, when you select **Set time window** or **Set sample rate** in the **Simulation** window, it will find the closest **Time window** or **Sample rate** without changing the **Bit rate**.

## Bit rate

The value of the global bit rate is in bits per second. All components can access this parameter (see [Figure 30](#)). The global bit rate can affect components such as Bit sequence generators because components that require this parameter use it as a default value.

An expression relative to this bit rate value is used to define the default value for the bandwidth or cutoff frequency of most electrical filters. When you change this global parameter, you can change the bit rate setting of all modules in the design simultaneously.

Figure 30 Global parameter Bit rate



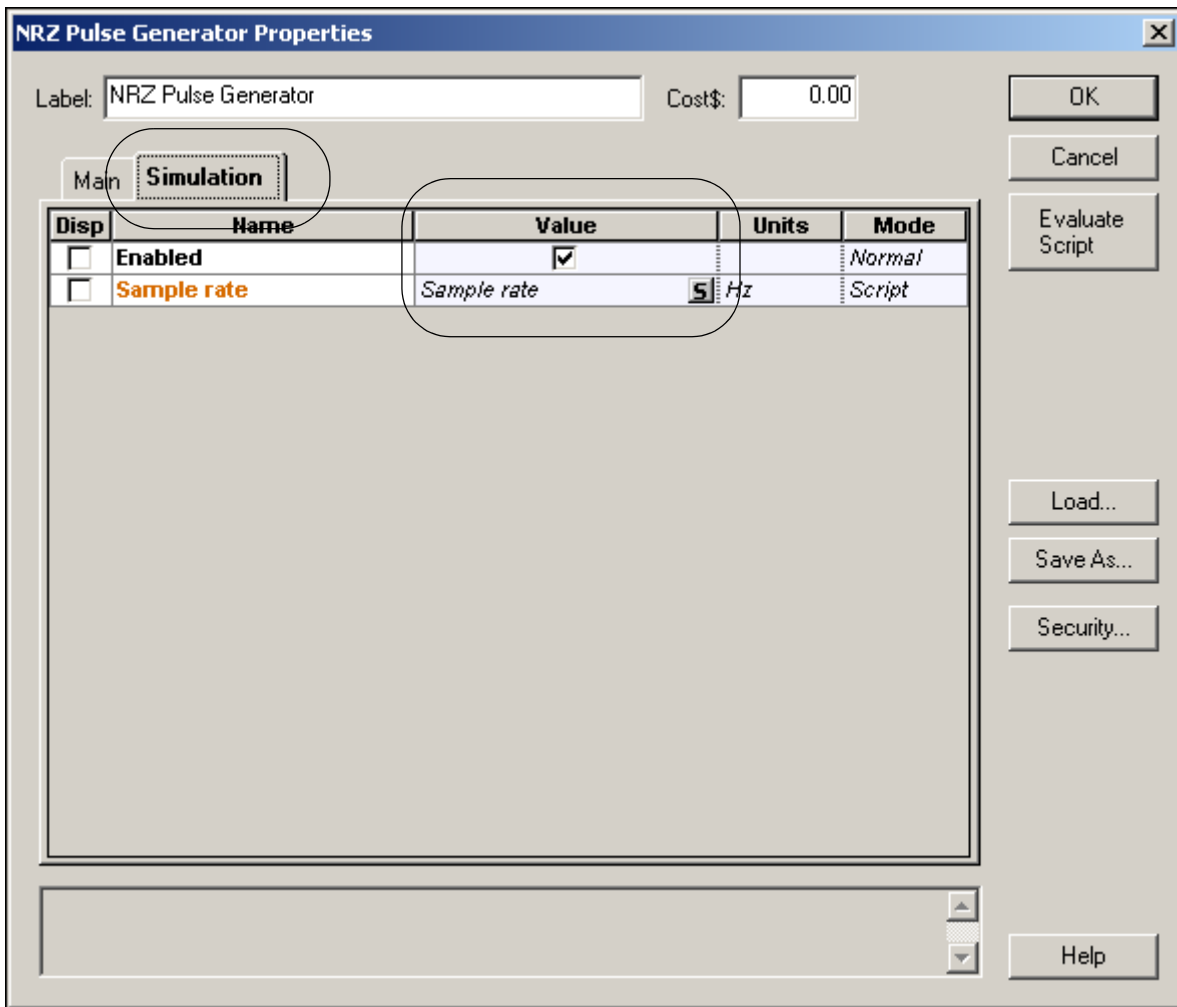
### Time window

Specifies in seconds the **Time window** of the simulation. OptiSystem shares the parameter **Time window** with all components. This means that each component works with the same **Time window**. Since the **Time window** defines the frequency spacing in the frequency domain, the sampled signal will always have the same frequency spacing. This parameter is best expressed in terms of the sequence length and the bit rate used during the simulation. It affects all components.

### Sample rate

Specifies the frequency simulation window or simulation bandwidth in Hz (see [Figure 31](#)). It can affect components such as pulse generators and optical sources that generate signals at different sample rates. It is often convenient to operate all modules in the design at the same sample rate. This can be done easily by using this global parameter. The default parameter for all components requiring sample rate is referred to as the global sample rate. When you change this global parameter, you can change the sample rate setting of all modules in the design simultaneously.

Figure 31 Global parameter Sample rate

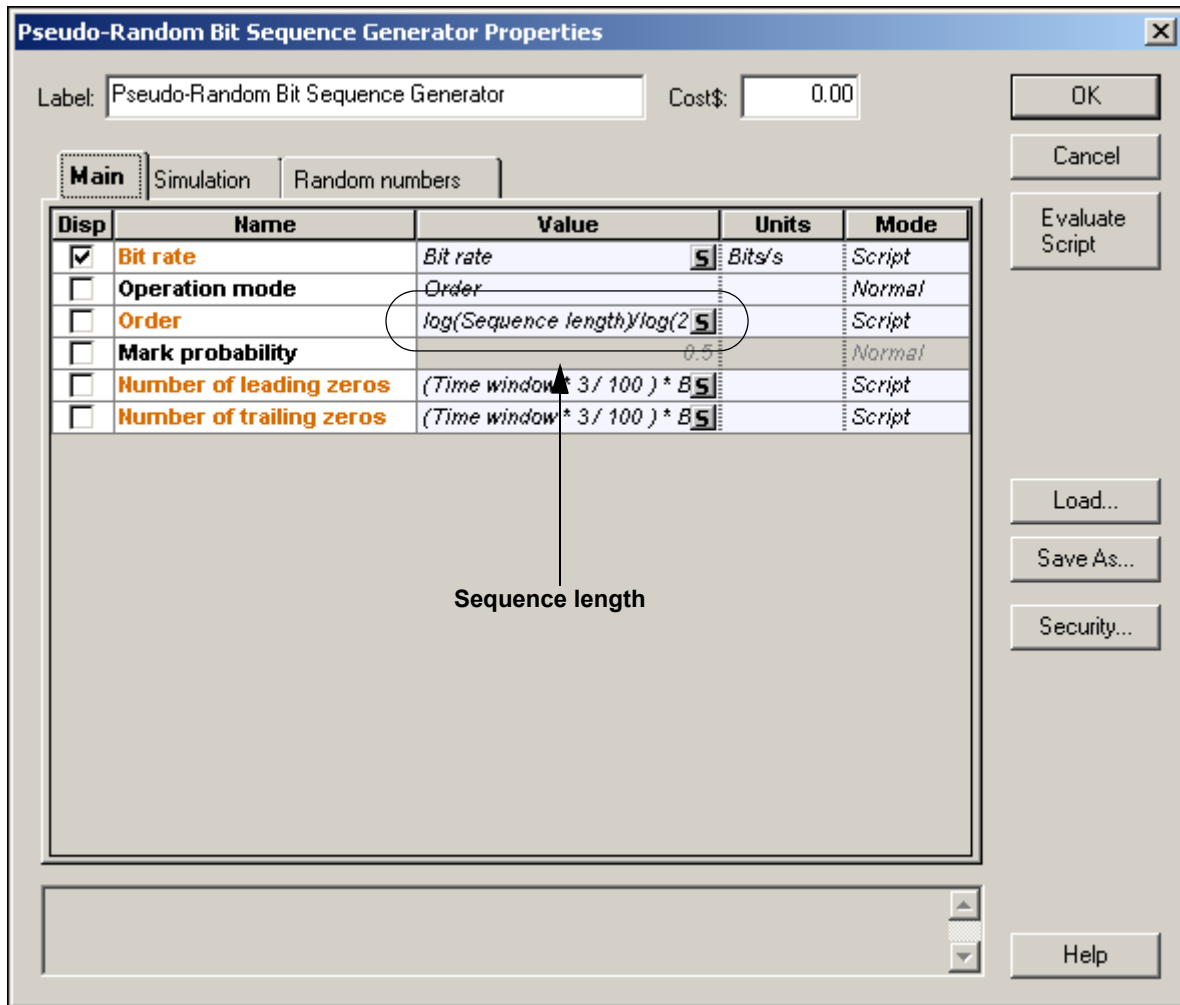




## Sequence length

The length of the bit sequence in number of bits. It must be a power of two.

Figure 32 Global parameter Sequence length



## Samples per bit

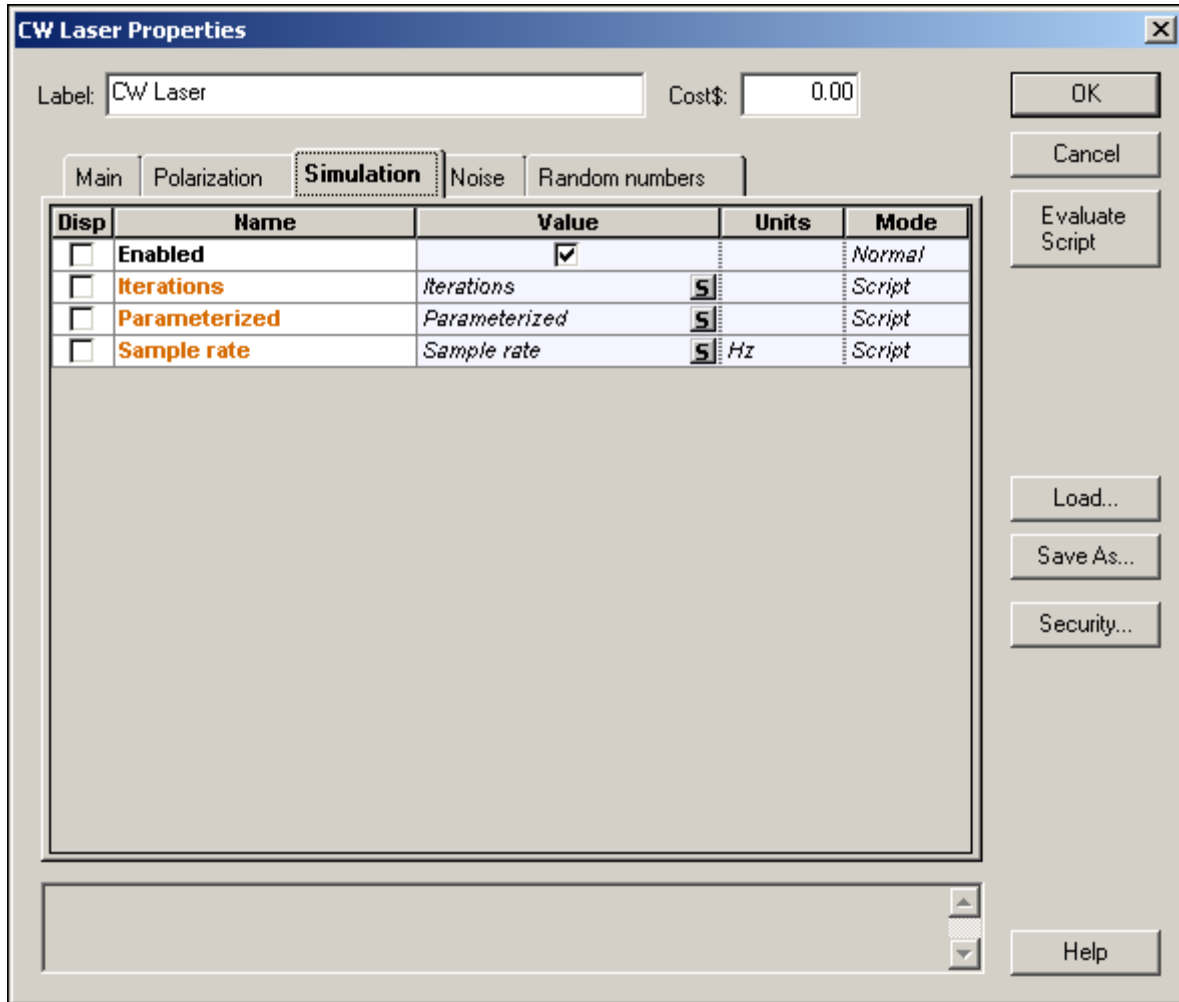
Number of samples for bit used to discretize the sampled signals. It must be a power of two.

## Number of samples

This read-only parameter shows the number of samples calculated by the product of **Sequence length** and **Samples per bit**.

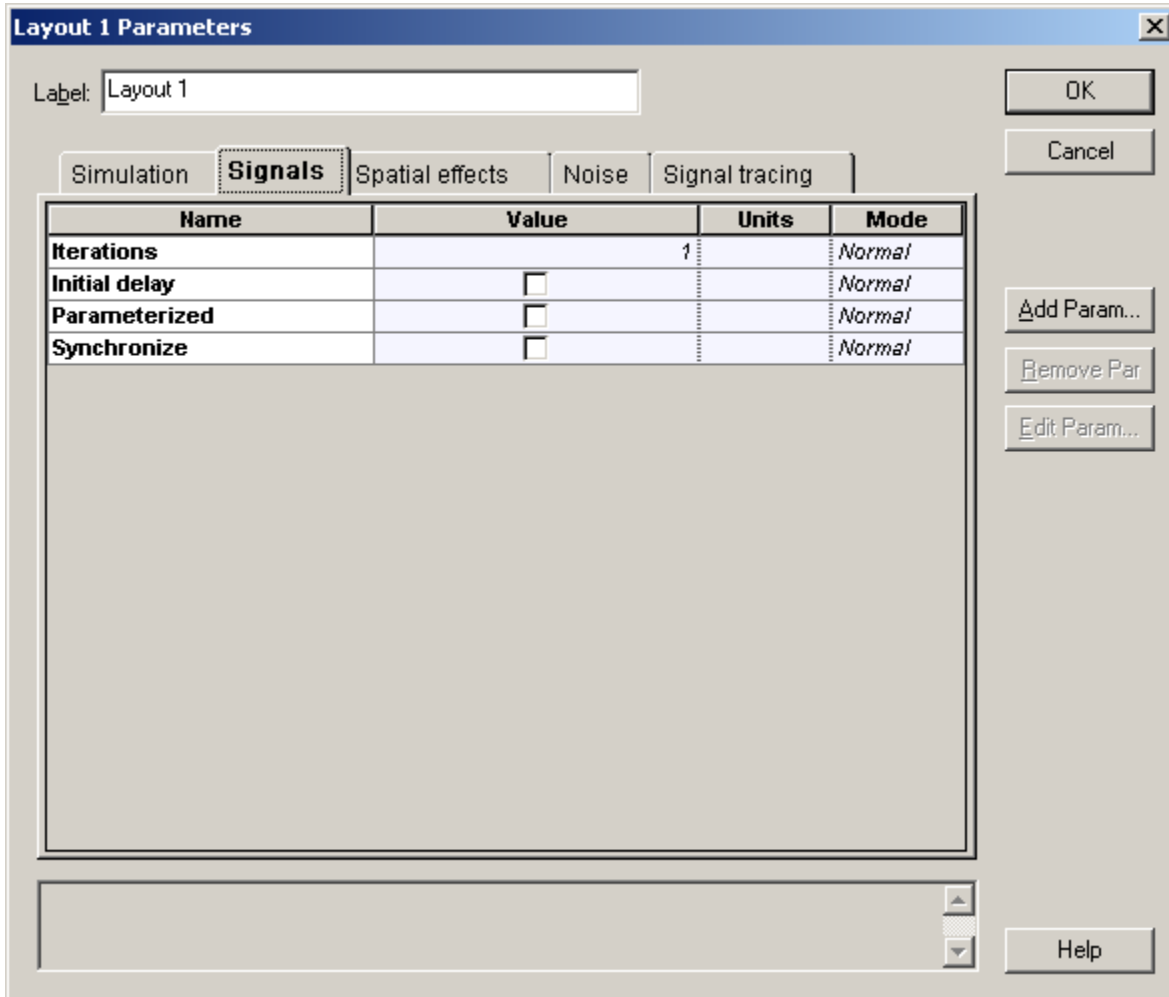


Figure 33 Global parameter iterations



## Signals parameters

Figure 34 Global parameters Signals



## Iterations

Number of signal blocks generated by each simulation. It mainly affects transmitters and components used in bidirectional simulations and in network ring design.

By increasing the parameter iterations a component will repeat the previous calculation until the number of calculations is equal to the iterations. Refer to the tutorial lesson: *Working with multiple iterations*.

## Initial Delay

This parameter forces a component to generate a null signal at each output port. It affects all components and it is mainly used in bidirectional simulations. The user does not have to add delays at the component input ports if using this parameter. Refer to the tutorial lesson: *Working with multiple iterations*.

## Parameterized

Defines whether the signal output will be sampled signals (disabled) or parameterized signals (enabled). It can affect components such as optical sources and optical pulse generators.

## Synchronize

Defines whether bit rates will be recalculated in order to make sure that the number of samples and the number of bits are both power of two numbers. It can affect components such as pulse generators, decoders and BER analyzers. It forces compatibility mode with previous versions of OptiSystem 7.

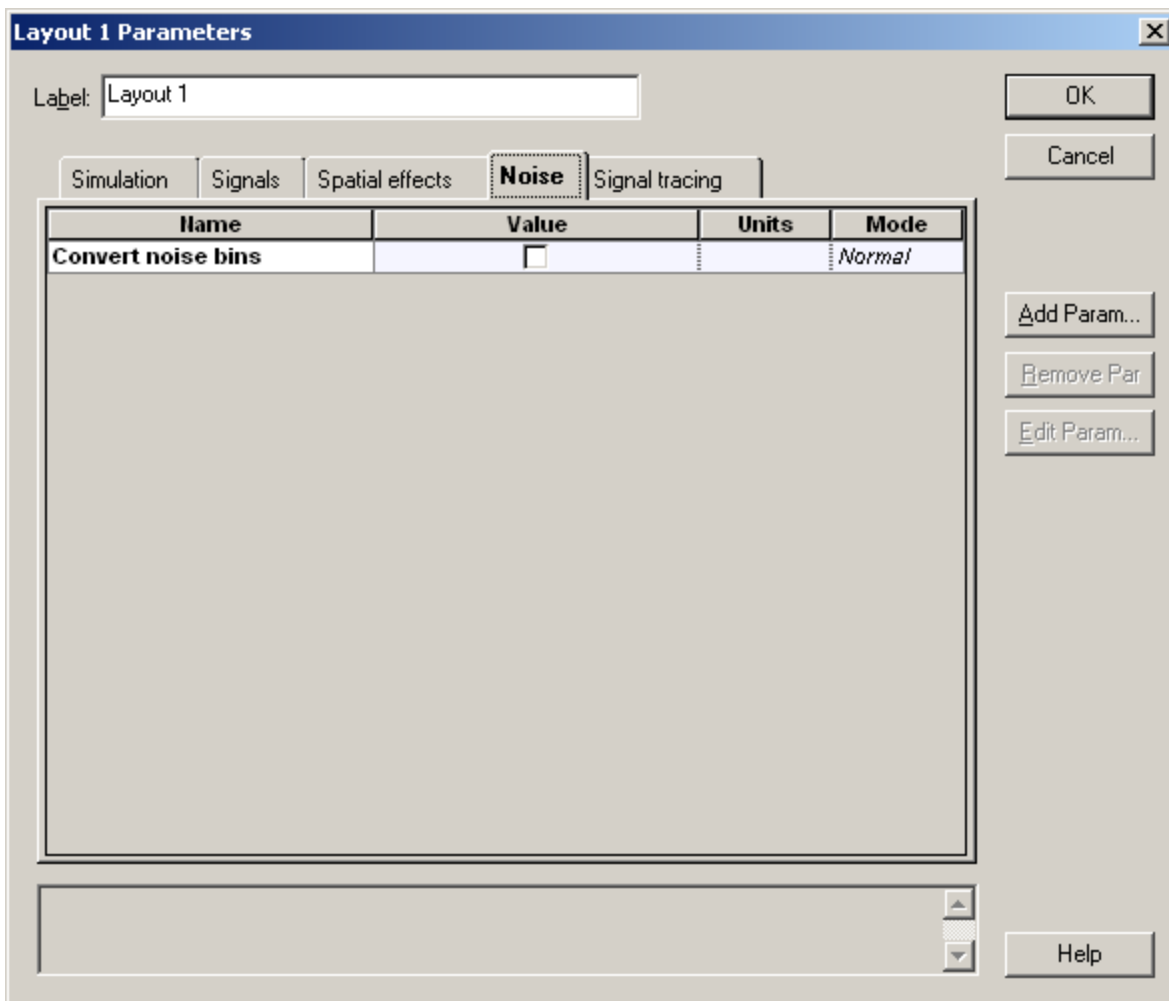


## Noise parameters

### Convert noise bins

Selects whether noise within a sampled band's frequency range is added to the sampled signal or represented separately as noise bins. The default value is disabled, which means the noise propagate is separated from the signals. It can affect the Erbium doped fiber amplifiers and the photo detectors.

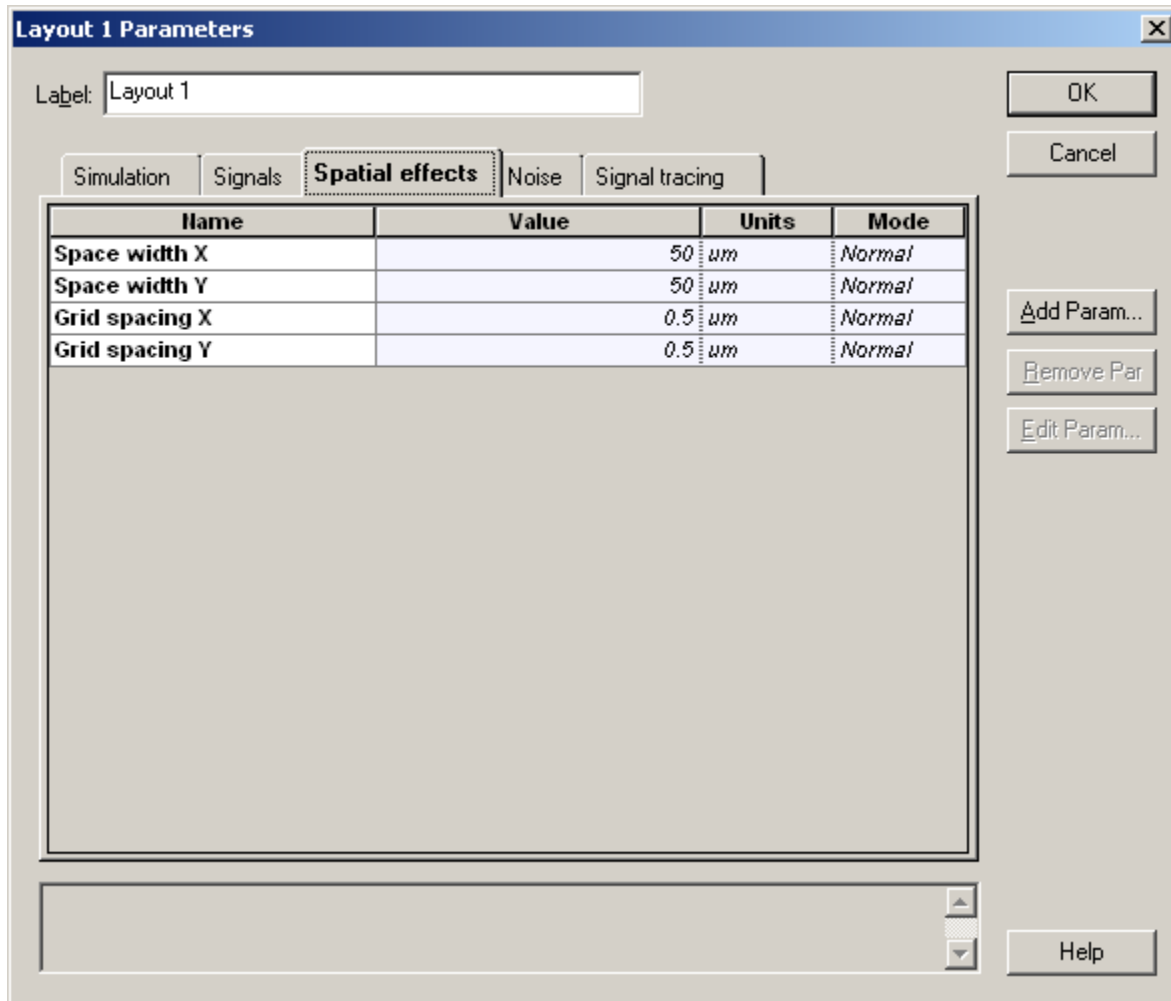
Figure 35 Global parameters Noise



## Spatial Effects Parameters

The spatial effects parameters affect the components that generate spatial modes, where the discretization space and the level of the discretization should be defined. The number of points per spatial mode is defined as the product of the number of points in the X and Y coordinates.

Figure 36 Global spatial effects parameters



### Space Width X

This is the space for the X coordinate.

### Space Width Y

This is the space for the Y coordinate.



## Grid Spacing Width X

The grid spacing for the X coordinate. The space width divided by the grid spacing gives the number of points in the X coordinate.

## Grid Spacing Width Y

The grid spacing for the Y coordinate. The space width divided by the grid spacing gives the number of points in the Y coordinate.

## Signal Tracing Parameters

OptiSystem allows for fast estimation of power and noise at each output port. This estimation is calculated every time a signal is sent to the component output port. The signal tracing parameters allow the user to control the calculation and presentation of the results.

Figure 37 Global signal tracing parameters

Layout 1 Parameters

Label:

Simulation Signals Spatial effects Noise **Signal tracing**

Name	Value	Units	Mode
Calculate signal tracing	<input checked="" type="checkbox"/>		Normal
Power unit	dBm		Normal
Frequency unit	THz		Normal
Decimal places	4		Normal
Sensitivity	-100	dBm	Normal
Resolution	0.1	nm	Normal
Calculate noise floor	<input type="checkbox"/>		Normal
Interpolation offset	0.5	nm	Normal

OK  
Cancel  
Add Param...  
Remove Par  
Edit Param...  
Help



### **Calculate Signal Tracing**

Defines if the signal will be traced.

### **Power Unit**

The units used to display the results (dBm, W or mW).

### **Frequency Unit**

The units used to display the results (Hz, m, THZ or nm).

### **Decimal Places**

The number of decimal places to use when displaying the results.

### **Sensitivity**

The minimum output power that the calculation can detect.

### **Resolution**

The spectral resolution bandwidth of the calculation.

### **Calculate Noise Floor**

Defines if the noise floor will be calculated using interpolation. This is an important parameter when the noise is added to the signal.

### **Interpolation Offset**

The interpolation offset from the signal channel center frequency used to estimate the noise floor.





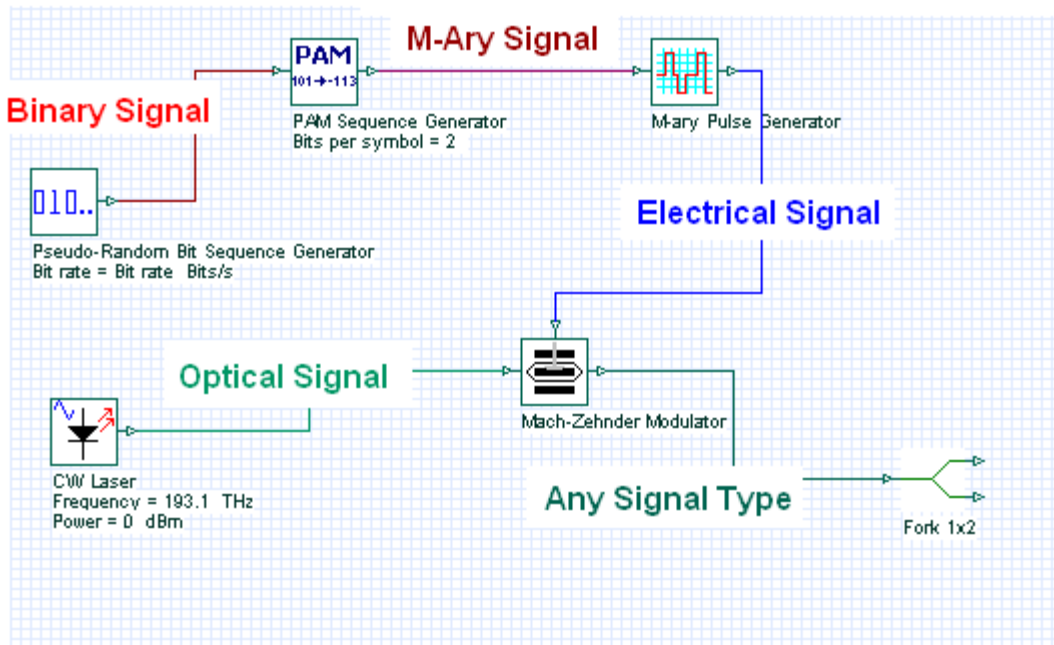
# Appendix B: Signal representation

To make the simulation tool more flexible and efficient, it is essential that it provides models at different abstraction levels, including the system, subsystem, and component levels. OptiSystem features a hierarchical definition of components and systems, allowing you to employ specific software tools for integrated and fiber optics in the component level and allowing the simulation to go as deep as the desired accuracy requires. Different abstraction levels imply different signal representations. The signal representation must be as complete as possible in order to allow efficient simulation.

There are five types of signals in the signal library:

Signal	Connection color
Binary	Red
M-Ary	Dark Red
Electrical	Blue
Optical	Green
Any Type	Dark Green

Figure 38 Signal types and connections

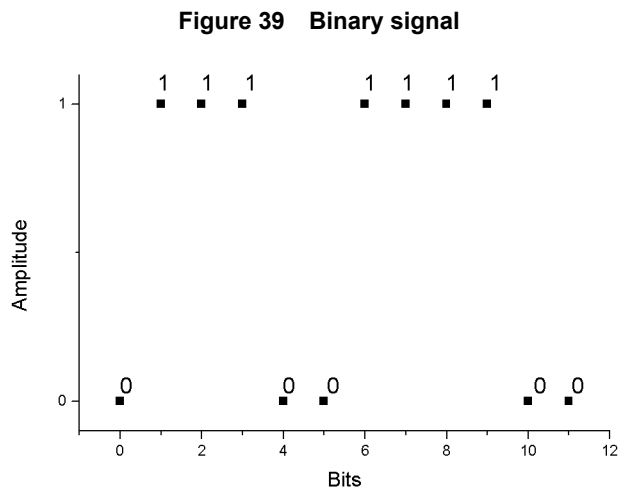


OptiSystem handles mixed signal formats in the Component Library for optical and electrical signals. It calculates the signals using different algorithms according to the desired simulation accuracy and efficiency.

## Binary signals

Binary signals are generated by components such as bit sequence generators. Pulse generators in the Transmitters Library and digital switches in the Network Library use this signal as input data.

A binary signal consists of a sequence of ones and zeros, or marks and spaces. The main property of the binary signal is the Bit rate (see [Figure 39](#)).



## M-Ary Signals

M-Ary signals are multilevel signals used for special types of coding, such as PAM, QAM, PSK, and DPSK. M-Ary signals are similar to the binary signals. However, M-Ary signals can have any level instead of only high (1) and low (0) levels, or marks and spaces. Refer to the digital modulation tutorial lessons.

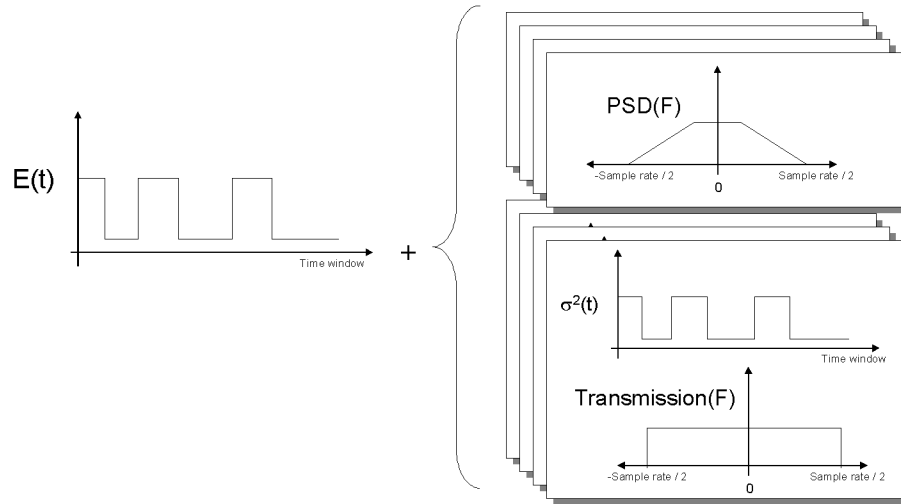
## Electrical signals

Electrical signals are generated by components such as pulse generators in the Transmitters Library and photodetectors in the Receivers Library.

Electrical signals consist of the sampled signal waveform in time domain. The main properties of the electrical signal are the signal noise variances in the time domain and the noise power spectral densities in the frequency domain.

When a pulse generator generates the electrical signal, there is no noise information with the signal because the signal is pure. If the electrical signal is generated by a photodetector, there are different sources of noise, some of which are time dependent and must be characterized by the time variance (for example, shot noise). Some of them are given as power spectral density (for example, thermal noise). The electrical signal creates the noise information according to the properties and the number of noise sources in the component (see [Figure 40](#)).

**Figure 40 Electrical signal - noise variance - PSD**

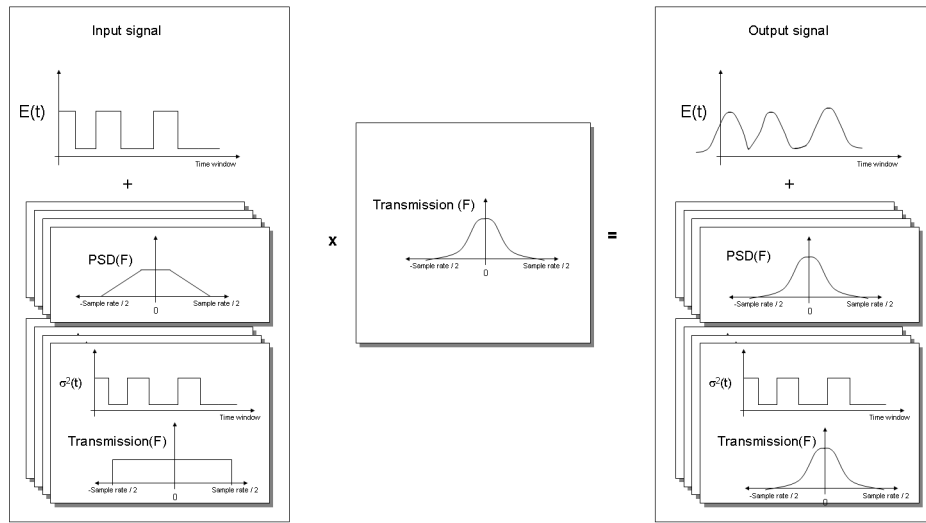


If the electrical signal is filtered, the noise PSD is affected immediately because the PSD is filtered based on the filter transfer function in frequency domain. If the noise is also characterized by the noise variance, it is not affected immediately. The information about the filter transfer function is saved in the frequency domain as a property of the noise. As a result, you can have a cascade of electrical filters and the electrical signal will keep track of the equivalent transfer function of the filters.

When using the noise variance for calculation of the signal noise, the information about the filters will be used to generate the equivalent noise bandwidth and will be applied to the noise variance (see [Figure 41](#)).

Electrical signals can also be represented by individual samples, allowing for time driven simulations. In order to simulate using individual samples the user should explicitly add the component "Convert to Individual Electrical Samples" into the layout. The signal and noise at the input signal will be added and converted into multiple samples. The number of samples is defined by the global parameter Number of samples. Refer to the tutorial lesson: *Working with individual samples*.

Figure 41 Filtering electrical signal

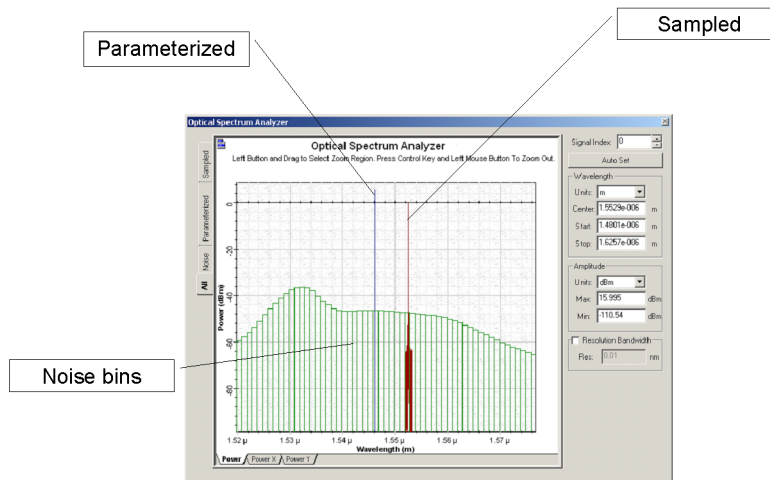


## Optical signals

Optical signals are generated by components such as lasers in the Transmitters Library. Optical signals accommodate different signal representations:

- [Sampled signals](#)
- [Parameterized signals](#)
- [Noise bins](#)

Figure 42 Mixed optical signal representation - Frequency domain



## Sampled signals

Optical signals can accommodate any arbitrary number of signal bands. In the simplest case, there is one single frequency band when a single, continuous frequency band represents the waveforms of all the modulated optical carriers. A single optical source (for example, CW Laser) produces a single frequency band. The band represents the complex sampled optical field of the signal in two polarizations. This type of optical signal is called a Sampled signal.

When two or more Sampled signals are combined, the individual signals will join into a new sampled signal if their simulation bandwidths overlap, or they are kept separated if the simulation bandwidth does not overlap. The resulting signal is called Sampled signals — in this case, each sampled signal is propagated using a separate sampled optical field.

### Example

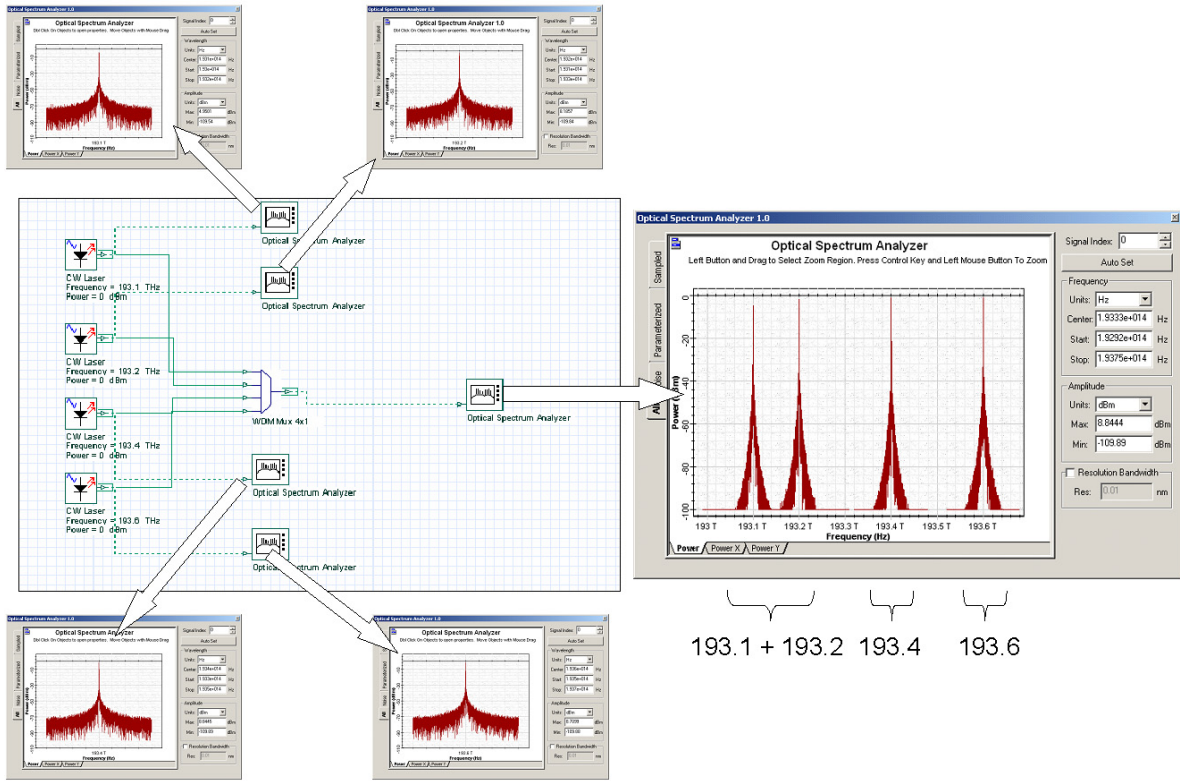
Signals are generated in each laser and are combined in the multiplexer. After the multiplexer, the channels at frequencies 193.1 and 193.2 THz overlap, so they are added to the same band (see [Figure 43](#)).

Sampled signals can also have spatial representation for the spatial modes. If you are using the multimode component library, the sampled signals will also have the spatial distribution of the signal power for both polarizations.

Optical signals can also be represented by individual samples, allowing for time-driven simulations. In order to simulate using individual samples, the user should explicitly add the component "Convert to Individual Optical Samples" into the layout. Only sampled signals can be converted into individual samples. The number of individual samples is defined by the global parameter Number of samples. If the input signal has multiple channels, each channel will have an individual sample and center frequency, allowing for WDM and Time-driven simulations. Refer to the tutorial lesson: *Working with individual samples*.



Figure 43 Overlapping channel frequencies



**Parameterized signals**

The signal description based on the Sampled signals covers the majority of physical phenomena affecting the system design. When designing a system where the power budget analysis and the fast signal-to-noise ratio estimations are the main performance evaluation results, signal channels can be approximated by their average power, assuming that the detailed waveform of their data streams are not important. One application example is the investigation of the transmission behavior of the central channels in dense WDM systems, or an estimation of the EDFA performance in the steady-state regime.

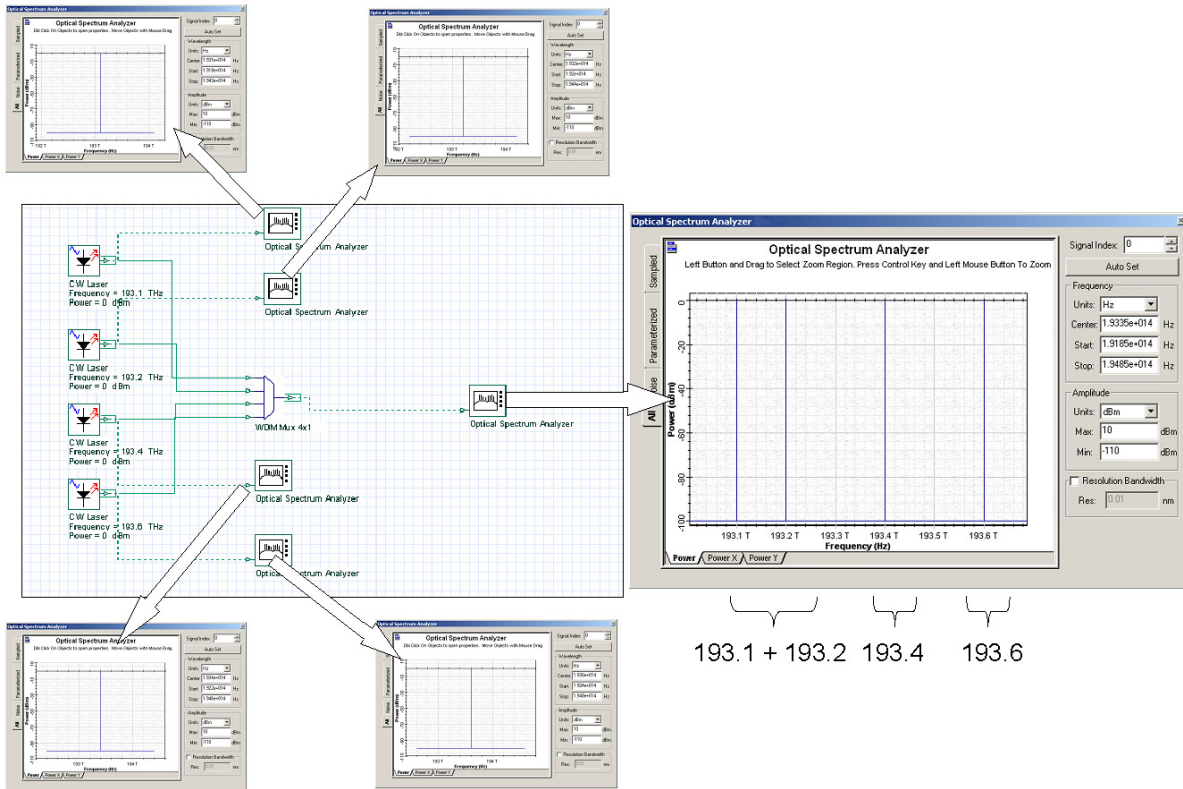
Parameterized Signals are time-averaged descriptions of the sampled signals based on the information about the optical signal (for example, Average power, Central frequency, and Polarization state).

**Example**

Signals are generated in each laser using parameterized representation and combined in the multiplexer. Signals are represented by power and frequency (see Figure 44).



Figure 44 Signals combined in the multiplexer



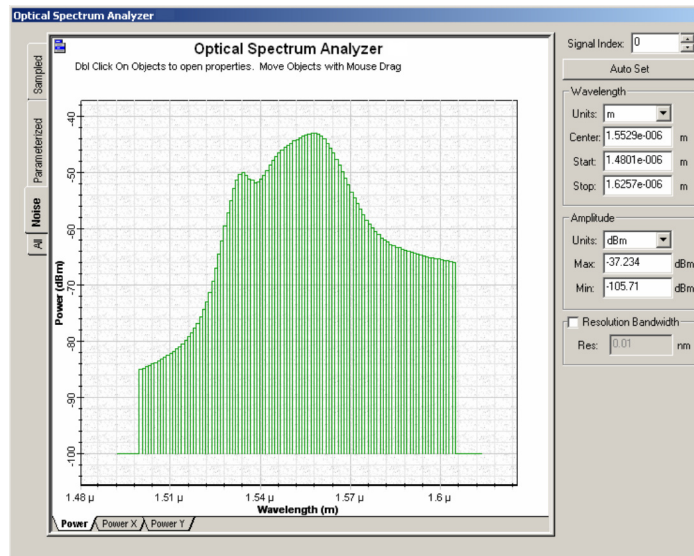
In the typical simulation of optical amplifiers in a WDM system, the model of an EDFA uses the static solution of the rate equations. Each WDM channel is a sampled signal with the information about the signal waveform (for example, center frequency, sample rate and a large number of samples). The WDM channels are close to each other, and can be in separate channels or together in the same band using a total field approach. The center frequency of the signal pump is far from the signal channels, making it inefficient to include the pump in the same band as the signal channels. There is no information content in the bandwidth range between the channels and pumps. The signal pump is also a CW signal, and can be represented as a parameterized signal by such statistical parameters as its power and wavelength.

The other type of signal is the ASE generated by the amplifier, which can also be represented in an alternative way by the power spectral density of the ASE bandwidth instead of the sampled signal. OptiSystem separates noise and signals in the spectrum, describing the noise by modifying the parameterized signals to another signal representation — Noise bins.

## Noise bins

Noise bins represent the noise by the average spectral density in two polarizations using a coarse spectral resolution. The resolution can be adapted to maintain the accuracy of the simulation. The main advantage of using Noise bins is to cover the wide spectrum of the optical signals or to represent the noise outside the Sample signals bandwidths. The noise bin representation is similar to the parameterized signals, including the polarization. The main difference is that noise bins are defined by the noise power density and the bandwidth of each noise bin instead of by the average power (see [Figure 45](#)).

**Figure 45 Noise bins generated by EDFA**

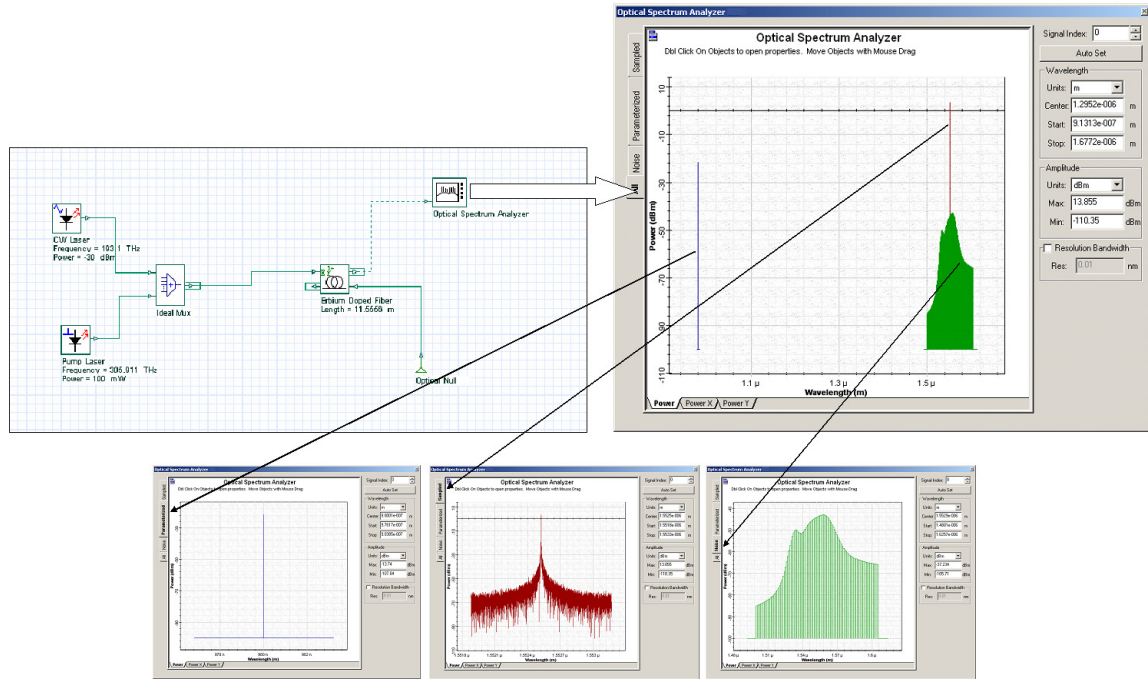


Noise Bins can be created whenever there is a source of optical noise, such as optical amplifiers. You define the initial resolution and bandwidth of the noise (see [Figure 46](#)).



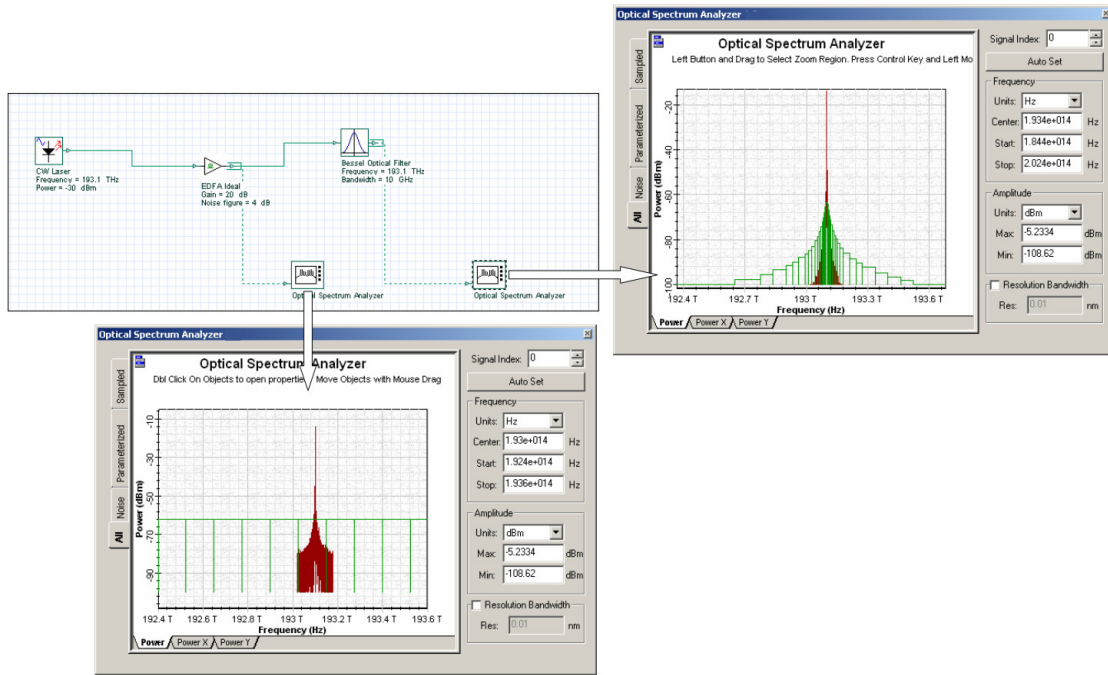


Figure 46 Mixed signals generated by EDFA



During transmission, the widths of the noise bins are adapted automatically to describe the filtering of the noise with a specified precision. The noise bins shrink in width as they propagate through the simulation in order to maintain the discretization accuracy (see [Figure 47](#)).

Figure 47 Filtering noise bins – adaptive band of each bin







**Optiwave**  
7 Capella Court  
Ottawa, Ontario, K2E 7X1, Canada

**Tel.: 1.613.224.4700**  
**Fax: 1.613.224.4706**

**E-mail: [support@optiwave.com](mailto:support@optiwave.com)**  
**URL: [www.optiwave.com](http://www.optiwave.com)**